

[LND]

italian lighting
for outdoor aesthetics

Unexpected Collection
1st edition

Everything
you can imagine,
nature
has already
created.

(Albert Einstein)

overview

INTRO

- 7 index by family
- 8 company profile

PRODUCTS

- 16 firefly
- 42 i-lantern
- 62 nest
- 86 tp-lamp

INFO

- 112 general information
- 112 symbols
- 113 finishes
- 113 quality certifications

index by family

FIREFLY

PENDANTS



36
firefly

BOLLARDS



38
firefly

I-LANTERN

GARDEN LAMPS



56
i-lantern

NEST

GARDEN LAMPS



82
nest 70



82
nest 80

TP-LAMP

GARDEN LAMPS



104
tp-lamp 20



108
tp-lamp 70

IT_ Soddisfare le esigenze di produzione senza compromettere la capacità delle generazioni future di fare lo stesso. Questa è la filosofia green di [LND] lighting e del Gruppo Bugatti.

Meeting production needs without compromising the ability of future generations to do the same.

This is the green philosophy of [LND] lighting and the Bugatti Group.

Being green: a major theme in today's society.

The concept of sustainability brings us back to an awareness of the world we live in. To the need to have a common goal, something to aspire to, acting with the best of intentions and respect for others. A goal that unites society and makes it better for everyone.

In [LND] Lighting, for example, sustainability means being able to meet production needs without creating a negative impact on the ecosystem we all inhabit. Thus enabling the next generations to do the same.

For a continuous and careful evolution: part of a common future.

IT_ Essere green: uno dei temi portanti nella società di oggi.

Il concetto di ecosostenibilità ci riconduce alla consapevolezza nei confronti del mondo in cui viviamo. Alla necessità di avere un obiettivo comune, un qualcosa a cui aspirare, agendo con i migliori intenti e nel rispetto degli altri. Un obiettivo che accomuna la società e la rende migliore, per tutti.

In [LND] Lighting, per esempio, sostenibilità significa riuscire a soddisfare le esigenze produttive senza creare un impatto negativo sull'ecosistema che tutti noi abitiamo. Permettendo, così, alle generazioni successive di poter fare lo stesso. Per un'evoluzione continua e attenta: parte di un futuro comune.

36,94%

renewable energy used
energia rinnovabile utilizzata

805.470,42 kg

CO₂ emissions avoided in one year
emissioni di CO₂ evitate in un anno

317,77 tep

tonnes of oil equivalent saved in one year
tonnellate equivalenti di petrolio risparmiate in un anno

1.699.304,69 kWh

energy produced in one year by the hydroelectric plant
and photovoltaic solar panels

*energia prodotta in un anno dalla centrale idroelettrica
e dai pannelli solari fotovoltaici*

In [LND], they firmly believe that the essence of light is to be found in the decorative, taking inspiration from Nature and its language.

UNEXP

[LND] reinterprets its own philosophy, transforming outdoor aesthetics into unexpected and charming ways.

Efficiency and performance, imperative and steadfast aspects in the company's production, are now part of a transversal thought that turns to the decorative and contemplates the inimitable authenticity of Nature.

This is how the **collection** was born. **Unexpected**. A story that narrates, made of discrete geometries and lighting accents, that are **protagonists of an organic dialogue** with the surrounding world. The new Landa lighting chapter rediscovers a dreamlike dimension, opening itself to visions that can make **matter live in synergy with the spirit of Nature**.

IT *L'essenza della luce si vota, in [LND], al decorativo traendo ispirazione dalla Natura e dal suo linguaggio. [LND] reinterpreta la propria filosofia, trasformando l'estetica outdoor in modi inattesi e suggestivi.*

L'efficienza e la performance, imperativi saldi nella produzione dell'azienda, sono ora parte di un pensiero trasversale che volge al decorativo e che contempla l'inimitabile autenticità della Natura.

Nasce, così, la collezione Unexpected. Una storia da raccontare fatta di geometrie discrete e accenti luminosi, che sono protagonisti di un dialogo organico con il mondo circostante. Il nuovo capitolo dell'illuminazione [LND] riscopre una dimensione onirica, aprendosi a visioni capaci di far vivere la materia in sinergia con lo spirito della Natura.



SELECTED

[LND] has always interpreted ideal lighting for outdoors. **It designs lighting paths in total harmony with the surrounding greenery.** Scenographic effects of luminescence are inserted into the luxurious and luxuriant fabric of meadows, woods and gardens, creating a scenario of silent promises in balance with the natural world. The design of the Unexpected products presents itself, in this way, in an unusual garment, without betraying the linear and minimal style typical of the company.





IT Da sempre interprete della luce ideale per outdoor, [LND] **disegna percorsi luminosi in totale armonia con il verde**. Gli scenografici effetti della luminescenza sono inseriti nel tessuto lussureggiante e rigoglioso di prati, boschi e giardini, a creare uno scenario di promesse silenziose in equilibrio con il mondo naturale. Il design dei prodotti Unexpected si presenta, così, in una veste inusuale, senza tradire lo stile lineare e minimal tipico dell'azienda.



COL- LEC- -TION

firefly

design by Landa R&D

FLOATING MAGIC.

[MAGIA FLUTTUANTE.]



CE ENEC



18 The full moon made fun of
the firefly:

"Maybe it's the effect of
the economy, but that light
you carry is weak ..."

"Yes, she said, but the
light is mine!"

Trilussa
Poet, writer and journalist

IT *La luna piena prese in giro la lucciola:
"Sarà l'effetto dell'economia, ma quel lume che porti è deboluccio..."
"Sì, disse quella, ma la luce è mia!"*

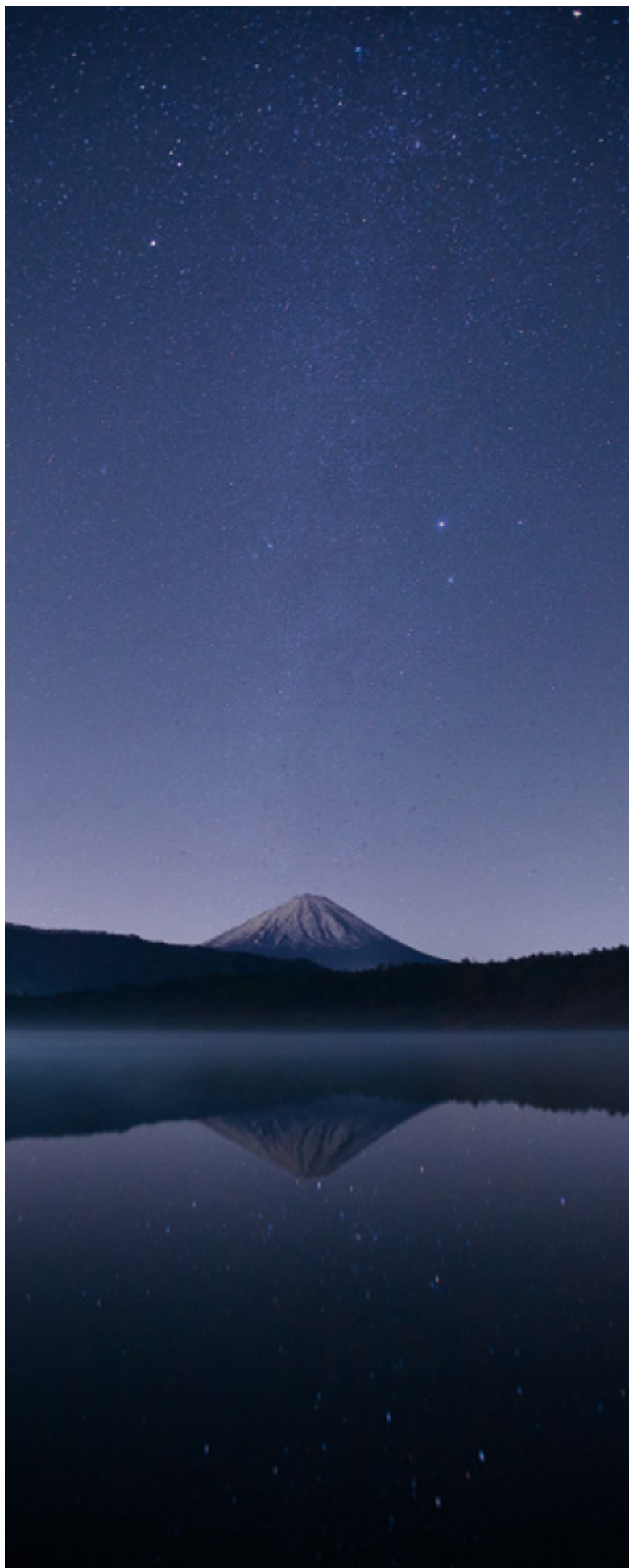



**The beauty of light emerges from nature,
it spreads and surfaces to make room
for the restless dancers of the theatre of
shadows.**

A distant memory, an innocent and rare
dream awakens. Darkness.

It lights up. Light. To then disappear,
deceiving and fleeting like a caress
in the night. Darkness.

IT *La bellezza della luce emerge dalla natura, si
irradia ed affiora per fare spazio alle danzatrici inquiete
del teatro delle ombre.*

*Si risveglia un ricordo lontano, un sogno innocente e raro.
Buio. Si accende. Luce. Per poi scomparire, ingannevole
e sfuggente come una carezza nella notte. Buio.*

"E lucevan
le stelle..."

(And the stars shone)

They are fireflies.

Twins of the stars that belong to the earth,
where the night shines and small lights
patter against the green drowsiness of
sleep. Light.

IT *Sono lucciole.*

*Gemelle delle stelle che appartengono alla terra,
dove la notte si rivela splendere e piccoli lumi
picchiettano il verde sopito nel sonno. Luce.*





A bucolic spectacle
which for Landa
turns into Firefly.

IT *Uno spettacolo bucolico
che per Landa si trasforma in Firefly.*



Outdoor spaces once again keep secrets, because the essence of light allows itself to be guided by the formidable simplicity of nature. Firefly becomes the magic of an everlasting night together with the most contemporary design.

IT *Gli spazi outdoor tornano a conservare segreti, perché l'essenza della luce si lasci di nuovo guidare dalla formidabile semplicità della natura. Firefly diventa la magia di una notte perpetua unita al design più contemporaneo.*

An outdoor luminaire,
with a poetic soul.

Firefly is the first unexpected product by Landa, when the magic of the outdoor world is enriched by a design with a clear reference to nature.

So, the tech soul of the Bugatti Group displays itself for the first time with minimalist decorative elements, with a wide reference to an oneiric and dreamlike universe.

IT *Un apparecchio per esterni, con un'anima poetica.*

Firefly è il primo prodotto unexpected by Landa, dove la magia del mondo outdoor si arricchisce di design dal chiaro richiamo naturale.

L'anima tech del Gruppo Bugatti si ammanta così, per la prima volta, di elementi propri del decorativo minimale, con un ampio rimando ad un universo onirico e sognante.

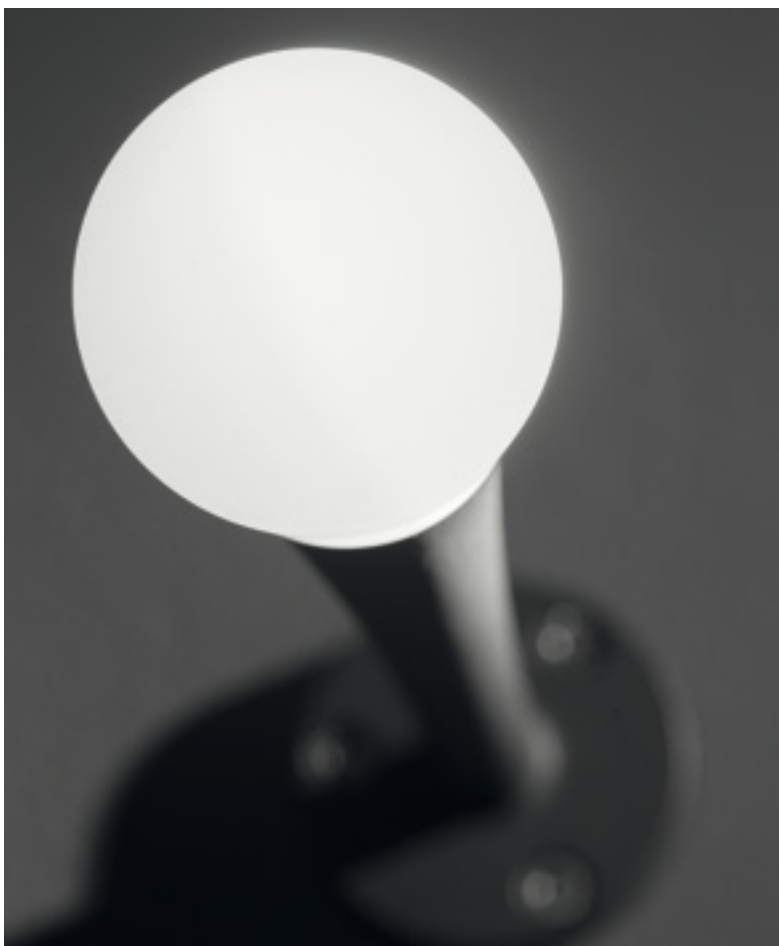

+
plus

Versatile mounting

Firefly is available in **various heights**.
Not just an idea, but a veritable communication
with surrounding nature is guaranteed by the
installation versatility (bollard and suspension)
which covers **all possible applications** for outdoor
garden areas.

IT *Firefly si presenta in diverse altezze. Non solo uno spunto, ma una vera e propria comunicazione con la natura circostante è garantita dalla versatilità di installazione (bollard e sospensione) che va a coprire tutte le possibili applicazioni per le zone verdi esterne.*



Dimmable light

A 360° light beam, uniform and attractive, with an opal screen in PMMA reminds us of fireflies thanks also to the fact that the luminaire can be **dimmed** and the colours given by the **change in colour temperature**.

IT *L'emissione luminosa a 360°, uniforme e suggestiva, con schermo opale in PMMA ricorda le lucciole grazie anche alla **dimmerabilità** dell'apparecchio e ai cromatismi dati dal **cambio della temperatura di colore**.*

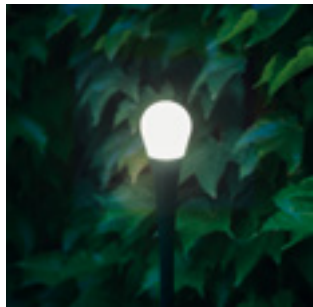

Light colour 4000K

IT *Temperatura colore 4000K*

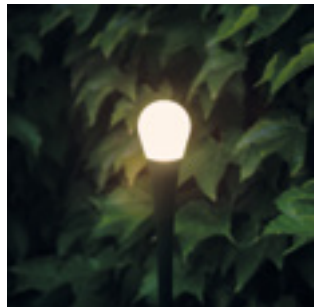

Light colour 3000K

IT *Temperatura colore 3000K*

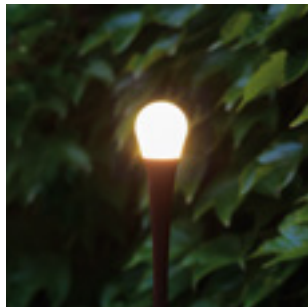

Light colour 2700K

IT *Temperatura colore 2700K*

PRODUCT RANGE

Firefly, the unexpected by Landa with suspension and ground applications. The ground version can be used in three installation possibilities: recessed into the paving, resting on the ground or fixed to the ground by stakes. Available in three different heights, 30 - 50 - 70 cm.

IT *Firefly, l'unexpected by Landa applicabile a sospensione e a terra. La variante da terra è utilizzabile in tre possibilità di installazione: con controcassa da pavimentazione, da appoggio e da terreno tramite picchetto. Disponibile in tre diverse altezze, 30 - 50 - 70 cm.*

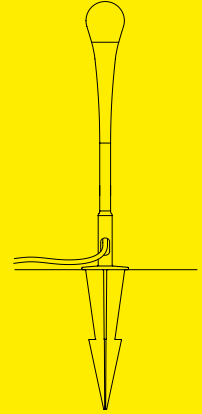
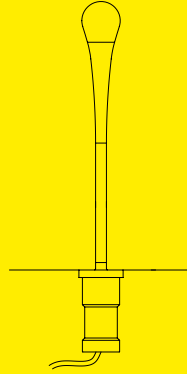

pendant

bollard

bollard

bollard

mounting

-

by housingbox

by plate

by spike

LIGHT BEAM

The 360° light beam creates a unique, spectacular, attractive effect. Perfect for gardens with hedges, flowerbeds, etc.

IT *L'emissione luminosa diffusa a 360° crea un effetto di luce unico, scenografico, suggestivo. Perfetto per aree verdi come siepi, aiuole e giardini.*

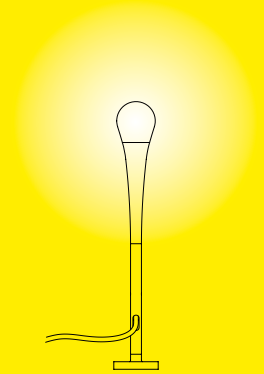
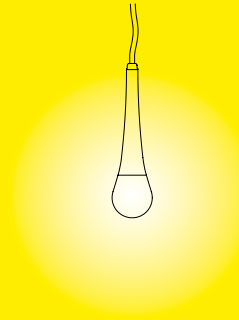

360°

360°

FINISHES



colour

grey

graphite

oxide

white

green



firefly

Change and modernisation: Firefly is an unexpected suspended firefly.

The suspension version of the product was created to valorise garden furniture such as gazebos and pergolas, or to create effects on plants and trees. The installation system makes the luminaire versatile and adaptable to the most particular outdoor needs.

A resistant and performing product, an atmospheric light spread through the opal PMMA element. The luminaire is fitted with a light source in LED technology, white, monochromatic with 2 W power or RGBW (by request). Available in graphite, oxide, white and green finishes.

IT *Cambiamento e modernizzazione: Firefly è una lucciola inaspettata sospesa. La versione del prodotto da sospensione, nasce per valorizzare strutture a corredo dei giardini, come gazebo e pergolati, o per creare effetti su piante e alberi. Il sistema di installazione rende l'apparecchio illuminante versatile e adattabile alle esigenze outdoor più particolari.*

Un prodotto resistente e performante, una luce d'atmosfera diffusa tramite l'elemento opale in PMMA. L'apparecchio è dotato di sorgente luminosa in tecnologia LED, white monocromatica con potenza 2 W, o RGBW (su richiesta). Disponibile nelle finiture graphite, oxide, white e green.



firefly

PENDANT

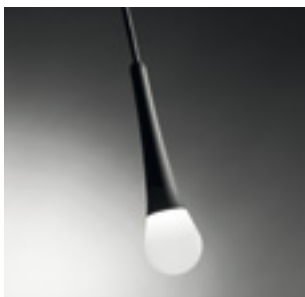
Wattage 2 WVoltage 24 VdcBeam 

TECHNICAL SPECIFICATIONS

Source lamp

Total wattage

Voltage

Control

Light colour

Luminous flux (*Source flux)

Luminous efficacy

McADAM steps

Beam

CRI

Life time

IP rating

IK rating

Insulation class

360°

LED 2 W

2 W

24 Vdc

Power supply not included •
dimmable on request

3000 K • other colours on request

119 lm (160 lm*)

59.5 lm/W

3

360°

> 90

L70 > 50.000 h Ta 40°C

IP 65

IK 08

III

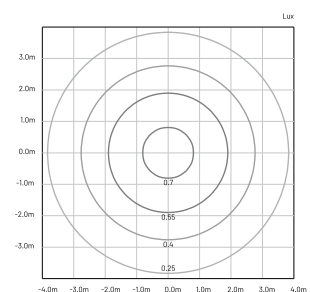
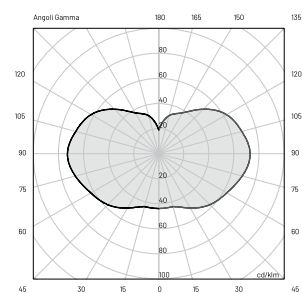





MATERIALS

<i>Body</i>	Extruded aluminium IT AW6026
<i>Diffuser</i>	Opal PMMA
<i>Finishing</i>	Polyester powder paint

ORDER CODE

FI30S0S X H B 7 Z _

<i>Finishing</i>	H	Grey	
	L	Graphite	
	V	Oxide	
	E	White	
	D	Green	

Example FI30S0S X H B 7 Z L

INCLUDED ACCESSORIES

<i>Code</i>	<i>Description</i>
-	2 m length cable -05RN-F
-	Cable clamp strip

AVAILABLE ACCESSORIES

<i>Code</i>	<i>Description</i>
0404M011	Single connection IP68
0409BT014	Transformer _ 24 Vdc - 12 W
0409BT015	Transformer _ 24 Vdc - 25 W
0409BT016	Transformer _ 24 Vdc - 100 W

firefly

BOLLARD



Wattage 2 W

Voltage 24 Vdc

Beam 

TECHNICAL SPECIFICATIONS

Source lamp	<u>360°</u>
Total wattage	<u>LED 2 W</u>
Voltage	<u>2 W</u>
Control	<u>24 Vdc</u>
Light colour	<u>Power supply not included • dimmable on request</u>
Luminous flux (*Source flux)	<u>3000 K • other colours on request</u>
Luminous efficacy	<u>119 lm (160 lm*)</u>
McADAM steps	<u>59.5 lm/W</u>
Beam	<u>3</u>
CRI	<u>360°</u>
Life time	<u>> 90</u>
IP rating	<u>L70 > 50.000 h Ta 40°C</u>
IK rating	<u>IP 65</u>
Insulation class	<u>IK 08</u>
	<u>III</u>

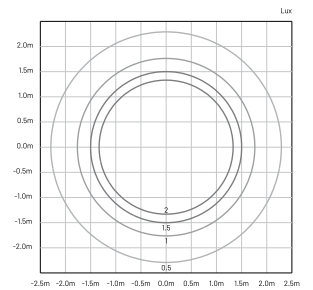
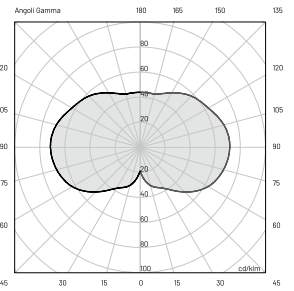

Mounting by housing box

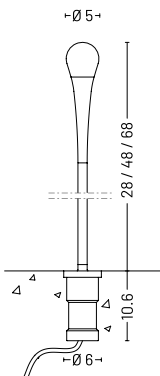

Mounting by plate

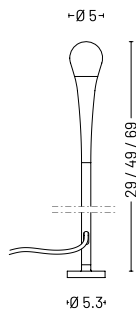



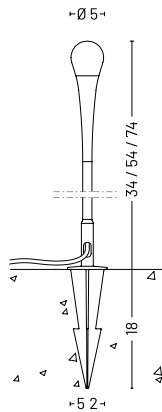

Mounting by spike



MATERIALS

<i>Body</i>	Extruded aluminium IT AW6026
<i>Diffuser</i>	Opal PMMA
<i>Finishing</i>	Polyester powder paint

ORDER CODE

FI 3 _ _ _ X H B 7 Z _	
<i>Finishing</i>	H Grey 
	L Graphite 
	V Oxide 
	E White 
	D Green 
<i>Height</i>	030 ~ 30 cm
	050 ~ 50 cm
	070 ~ 70 cm
<i>Model</i>	0 Mounting by housing box
	1 Mounting by plate
	2 Mounting by spike
<i>Example</i>	FI 3 0 030 X H B 7 Z L

INCLUDED ACCESSORIES

<i>Code</i>	<i>Description</i>
-	0.5 m length cable -05RN-F
-	Housing box
-	Mounting spike

AVAILABLE ACCESSORIES

<i>Code</i>	<i>Description</i>
0404M011	Single connection IP68
0409BT014	Transformer _ 24 Vdc - 12 W
0409BT015	Transformer _ 24 Vdc - 25 W
0409BT016	Transformer _ 24 Vdc - 100 W





i-lantern

design by Landa R&D

THE MAGIC OF LIGHT.

[MAGIA DI LUCE.]



CE ENEC



44 I feel as if I am standing
before a **magic lantern**,
I look at the little men
and the little horses
before me, which go here
and there, and I often
wonder if it isn't
an optical illusion.

Johann Wolfgang Goethe
German writer, poet and playwright

IT *Mi par di stare davanti a una **lanterna magica**, guardo gli omini
e i cavallucci davanti a me, che si fanno in qua e in là, e spesso mi chiedo
se non si tratti di un'illusione ottica.*



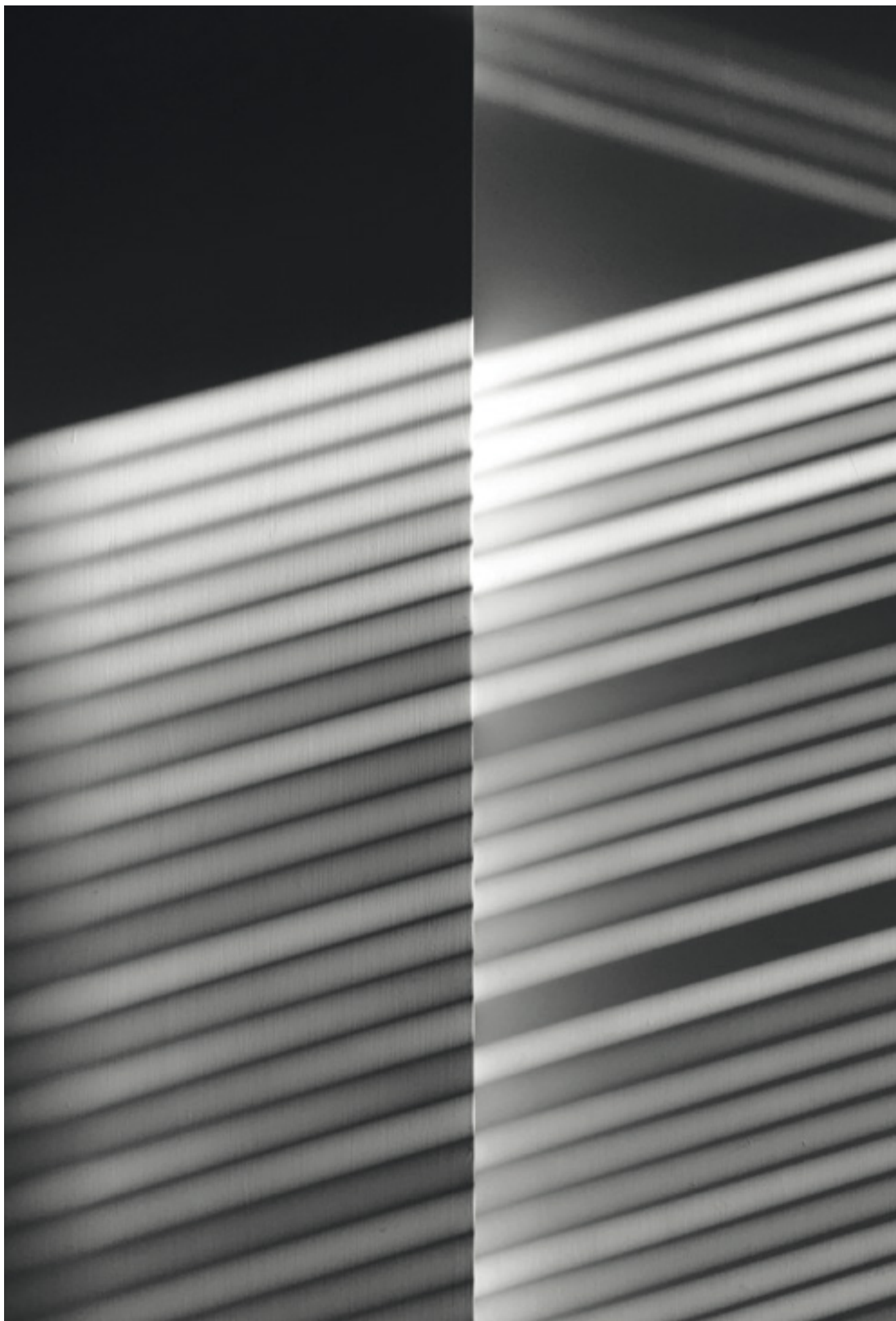

**Shadows that dance,
shadows that take shape and vibrate.**

A distant lantern that illuminates bodies that move in the night and observes the kisses of lovers, stolen from the night. Small steps diminish in the light, projected afar. A sweet, sensual light, a light so beautiful that it can be reached. A real dream.

IT *Ombre che danzano,
ombre che prendono forma e vibrano.*

Una lanterna, lontana, illumina corpi che si muovono nella notte ed assiste ai baci degli amanti, rubati alla notte. Piccoli passi scemano nella luce, proiettata lontano. Una luce dolce e sensuale, una luce così bella da essere raggiungibile. Un sogno reale.

Technology & Soul

I-Lantern is characterised by a strong personality, a direction of light with a 10W powerful heart. An aesthetic fusion living parallel with a minimal design to provide a wide range of possible installations.

IT *Tecnologia & Anima*

***I-Lantern** si presenta caratterizzato da una forte personalità, una regia luminosa dal cuore potente 10W. Una fusione estetica che vive in parallelo ad un design minimal per declinarsi in molteplici possibili installazioni.*





Off

IT spento



half power

IT mezza potenza



full power

IT piena potenza

The standing version is also re-chargeable and self-feeding, has an autonomy of 3 hours at the maximum power and is fitted with a red leather handle, suitable for moving and positioning the device in its desired location. The diffused beam light is dimmable in three different modes.

IT *La variante da appoggio è anche ricaricabile, ha un'autonomia di 3 ore alla massima potenza ed è inoltre dotata di una maniglia in cuoio color rosso adatta a spostare e posizionare l'apparecchio nella locazione desiderata. La luce dal fascio diffuso è dimmerabile in tre modalità differenti.*

+ plus

A complete range

Gardens, walkways, arcade, tables. Thanks to the completeness of the range, with I-Lantern an entire outdoor context can be illuminated with aesthetic consistency and high performance.

IT *Giardini, camminamenti, portici, tavoli. Grazie alla completezza di gamma, con I-Lantern è possibile illuminare con coerenza estetica e alte performance un intero contesto outdoor.*

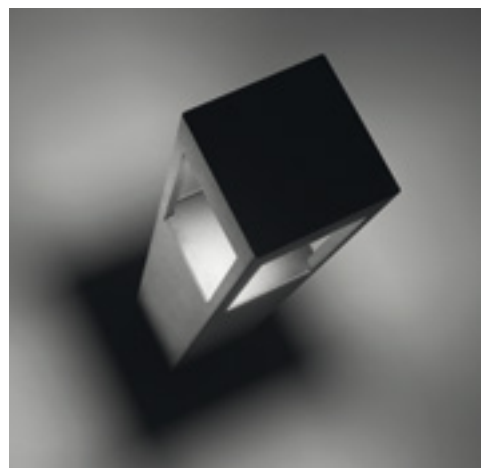
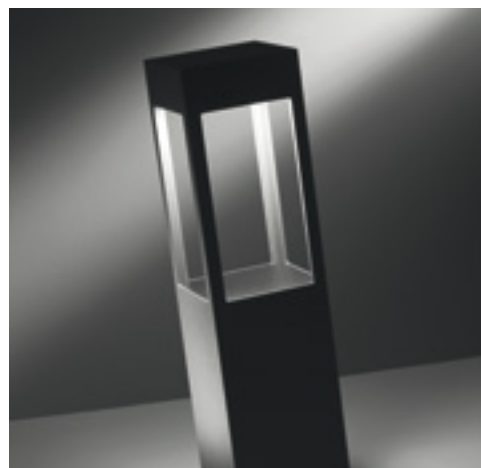

I-Lantern portable is available in standard version with 10W power and rechargeable version with 4W power.

Two objects of maximum versatility that can be transformed into objects of furniture to characterize any environment with style.

IT *I-Lantern portable è disponibile in versione standard con potenza 10W e ricaricabile con potenza 4W. Due oggetti dalla massima versatilità che si trasformano in oggetti d'arredo per caratterizzare ogni ambiente con stile.*

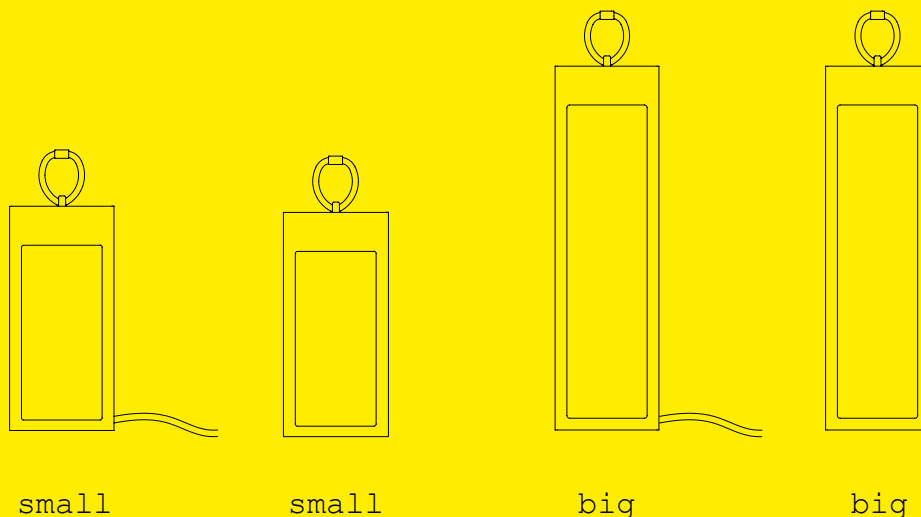

wattage standard 10 W rechargeable 4 W standard 10 W rechargeable 4 W

LIGHT BEAM

Dimmable through a touch on/off system, the light of I-Lantern is diffused, pleasant and never glaring thanks to the opal diffuser.

IT *Dimmerabile attraverso un sistema di accensione on/off touch, la luce di I-Lantern è diffusa, piacevole e mai abbagliante grazie al diffusore opale.*

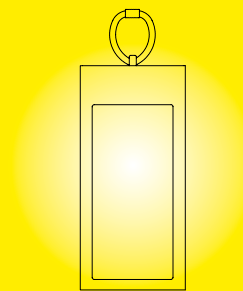

diffuse

FINISHES



colour grey graphite oxide white black

i-lantern

An interactive cage to seize the light, I-Lantern in the garden lamp version has a strong personality, a light direction with a diffused beam with a powerful 10 W heart.

An aesthetic fusion which lives in parallel with a minimal design available in a wide range of possible outdoor installations in parks and gardens.

The portable I-Lantern is fitted with a red leather handle, suitable for moving and positioning the device in its desired location.

The carrying frame measures 150 x 150 x h 300 mm, is made in extruded aluminium and can be customised in four finishes made by powder coating, graphite, oxide, white and black. The alluring light of I-Lantern is enhanced by an opal, polycarbonate diffuser, the beam is diffused, available also in the re-chargeable and self-feeding version with autonomy of 3 hours at the maximum power. Possibility of management and dimming via Bluetooth on request.

IT *Una gabbia interattiva per ghermire la luce, I-Lantern nella variante garden lamp ha una forte personalità, una regia luminosa con fascio diffuso dal cuore potente 10 W.*

Una fusione estetica che vive in parallelo a un design minimal per declinarsi in molteplici possibili installazioni outdoor in parchi e giardini.

I-Lantern portable è dotato di una maniglia in cuoio color rosso adatta a spostare e posizionare l'apparecchio nella locazione desiderata. Il telaio portante misura 15 x 15 x h 30 cm, è realizzato in alluminio estruso ed è personalizzabile in quattro finiture realizzate tramite verniciatura a polveri, graphite, oxide, white e black. La luce suggestiva di I-Lantern è enfatizzata da un diffusore opale in polycarbonato, l'emissione luminosa è diffusa, disponibile anche nella versione ricaricabile con un'autonomia di 3 ore alla massima potenza.

Possibilità di gestione e dimmerazione via Bluetooth su richiesta.



i-lantern

GARDEN LAMP



Wattage 10 W (standard)
4 W (rechargeable)

Voltage 220-240 Vac (standard)

Beam



TECHNICAL SPECIFICATIONS

Source lamp

Total wattage

Voltage

Control

Light colour

Luminous flux (*Source flux)

Luminous efficacy

McADAM steps

Beam

CRI

Life time

IP rating

IK rating

Insulation class

DIFFUSE STANDARD

LED 10 W

12.5 W

220-240 Vac, 50-60Hz

On/Off

3000 K

700 lm (1360 lm*)

56 lm/W

3

diffuse

> 90

L70 > 50.000 h Ta 40°C

IP 65 (schuko plug IP44)

IK 08

Cable c/w schuko-CEE 7/4 - type F plug

Note

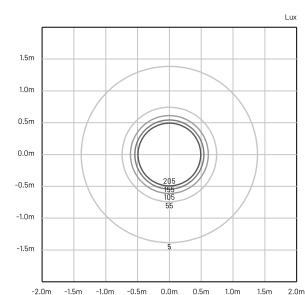
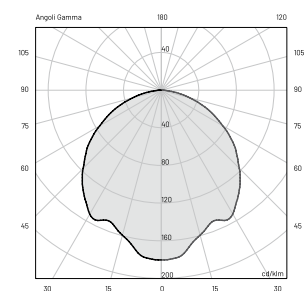
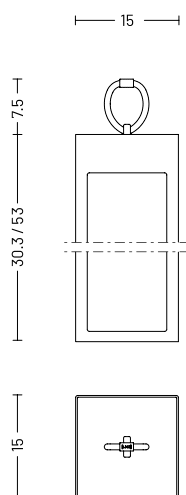

DIFFUSE RECHARGEABLE SWITCH





LED 4 W
4 W
-
On/Off
3000 K
220 lm (440 lm*)
55 lm/W
3
diffuse
> 90
-
IP 65
IK 08
-
charging port: USB TYPE-C 5 Vdc - 1A
3 steps touch control:
• off
• half power (7 h of light)
• full power (3 h of light)

MATERIALS

Body	Die-cast aluminium EN47100 and extruded aluminium IT-AW6060 Red leather handle with chromed elements
Diffuser	Opal polycarbonate
Finishing	Polyester powder paint

ORDER CODE

LN 7 _ POR D H B _ 0 _

Finishing	H	Grey	
	L	Graphite	
	V	Oxide	
	U	White	
	G	Black	
	Supply	1	Standard
4		Rechargeable	
Height	0	30 cm	
	5	53 cm	

Example LN 7 0 POR D H B 1 0 L

INCLUDED ACCESSORIES**STANDARD**

Code	Description
-	2.5 m length cable

RECHARGEABLE

Code	Description
-	3.7 Vdc Li-Ion battery

AVAILABLE ACCESSORIES**RECHARGEABLE**

Code	Description
0409BT051	5 Vdc - 3A Universal USB TYPE-C Charger

i-lantern

GARDEN LAMP



Wattage 4 W (rechargeable)

Voltage -

Beam 

TECHNICAL SPECIFICATIONS

Source lamp	<u>LED 4 W</u>
Total wattage	<u>4 W</u>
Voltage	<u>-</u>
Control	<u>On/Off Touch Dimmer</u>
Light colour	<u>3000 K</u>
Luminous flux (*Source flux)	<u>220 lm (440 lm*)</u>
Luminous efficacy	<u>55 lm/W</u>
McADAM steps	<u>3</u>
Beam	<u>diffuse</u>
CRI	<u>> 90</u>
Life time	<u>-</u>
IP rating	<u>IP 40</u>
IK rating	<u>IK 08</u>
Insulation class	<u>-</u>

DIFFUSE RECHARGEABLE TOUCH

Source lamp	<u>LED 4 W</u>
Total wattage	<u>4 W</u>
Voltage	<u>-</u>
Control	<u>On/Off Touch Dimmer</u>
Light colour	<u>3000 K</u>
Luminous flux (*Source flux)	<u>220 lm (440 lm*)</u>
Luminous efficacy	<u>55 lm/W</u>
McADAM steps	<u>3</u>
Beam	<u>diffuse</u>
CRI	<u>> 90</u>
Life time	<u>-</u>
IP rating	<u>IP 40</u>
IK rating	<u>IK 08</u>
Insulation class	<u>-</u>

charging port: USB TYPE-C 5 Vdc - 1A

3 steps touch control:

- off
- half power (7 h of light)
- full power (3 h of light)

Note

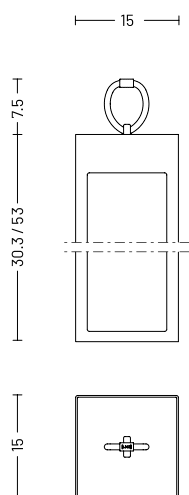





MATERIALS

<i>Body</i>	Die-cast aluminium EN47100 and extruded aluminium IT-AW6060 Red leather handle with chromed elements
<i>Diffuser</i>	Opal polycarbonate
<i>Finishing</i>	Polyester powder paint

ORDER CODE

LN7_POR DHB 4 T _

<i>Finishing</i>	H	Grey	
	L	Graphite	
	V	Oxide	
	U	White	
	G	Black	
<i>Height</i>	0	30 cm	
	5	53 cm	

Example LN7**0**POR DHB 4 T L

INCLUDED ACCESSORIES

RECHARGEABLE

<i>Code</i>	<i>Description</i>
-	3.7 Vdc Li-Ion battery

AVAILABLE ACCESSORIES

RECHARGEABLE

<i>Code</i>	<i>Description</i>
0409BT051	5 Vdc - 3A Universal USB TYPE-C Charger

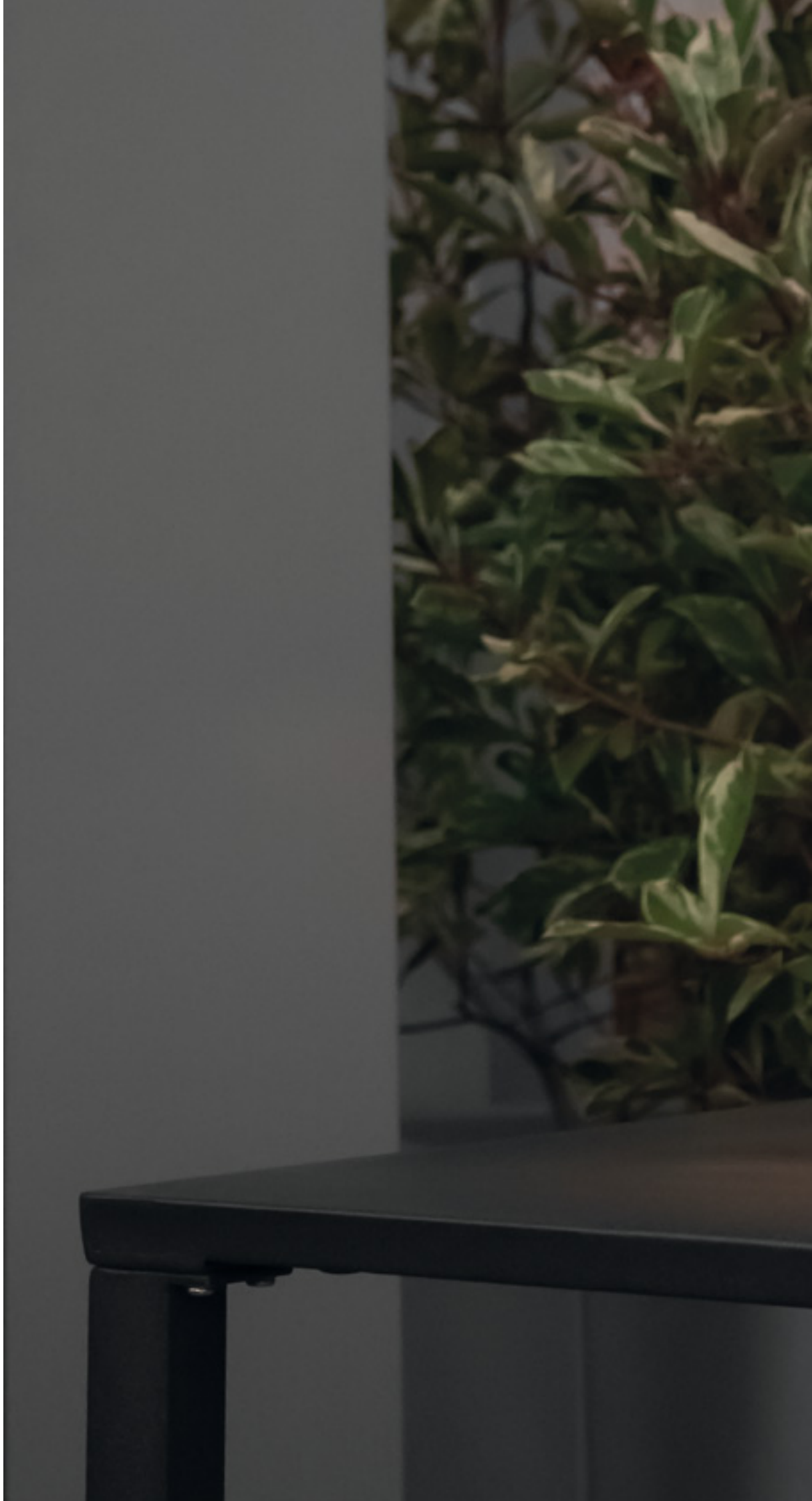



nest

design by Landa R&D

NATURE AND LIGHT.

[NATURA E LUCE.]

CE ENEC



Nature! We are **surrounded**
by her and **locked in** her
clasp: powerless to leave
her, and powerless to come
closer to her. Unmasked
and unwarned she takes us
up into the whirl of her
dance, and hurries on with
us till we are weary and
fall from her arms.

Johann Wolfgang Goethe
German writer, poet and playwright

IT **Natura!** Ne siamo **circondati** e **avvolti** - incapaci di uscirne, incapaci di penetrare
più addentro in lei. Non richiesta, e senza preavviso, essa ci afferra nel vortice della sua
danza e ci trascina seco, finché, stanchi, non ci sciogliamo dalle sue braccia.

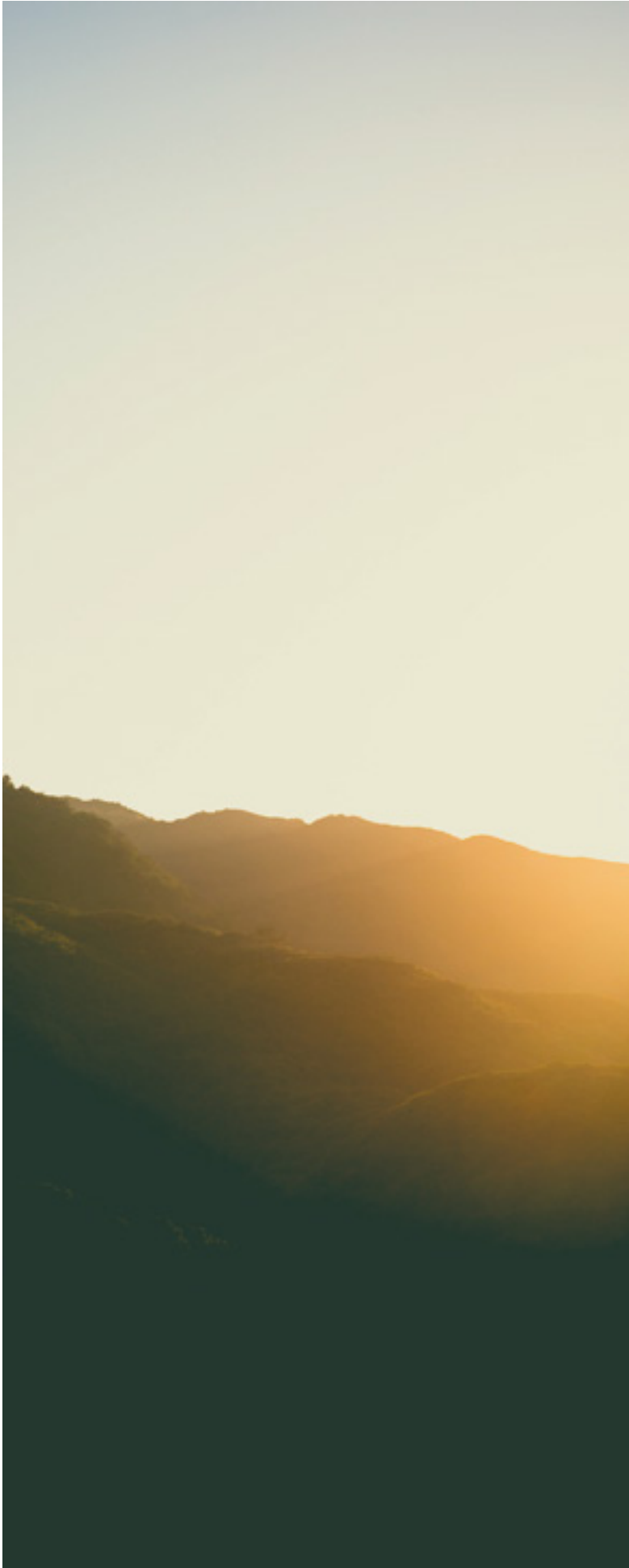



Ode to man and nature!

Without a coded language, the first learns from the second the sweetness inside hostility, protection in uncertainty in a fight without weapons against the unforeseeable.

It is in this way that the need to create a place called home exists, to build a refuge where children can live, away from inclement weather and danger.

A nest. Like a wild song translated into the language of man.

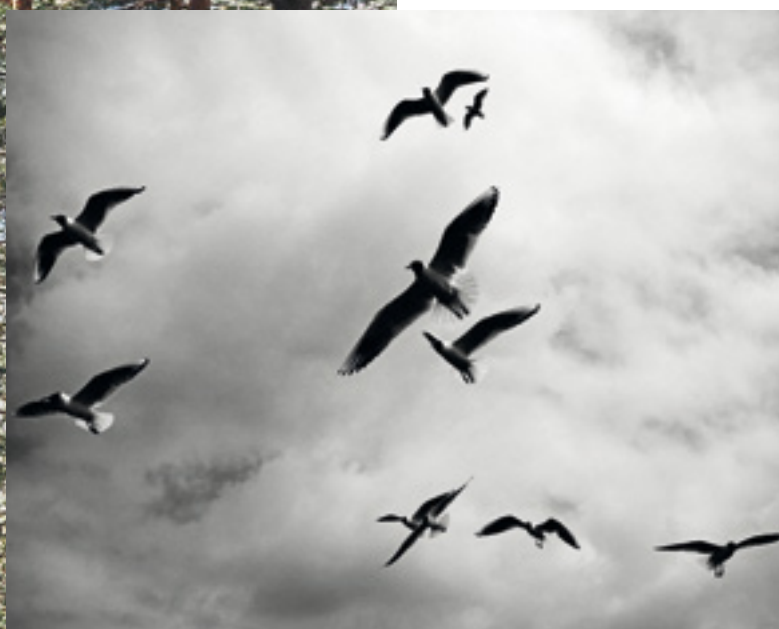

IT *Ode all'uomo e alla natura!*

Senza linguaggio codificato, il primo impara dal secondo la dolcezza nell'ostilità, la protezione nell'insicurezza in una lotta senza armi contro l'imprevedibile.

Vive, così, il bisogno di creare un luogo chiamato casa, per la costruzione di un rifugio dove crescere una prole al riparo da intemperie e pericoli.

Un nido. Come una canzone selvatica tradotta nel linguaggio dell'uomo.



The unexpected can be found in Nest, hiding among the leaves to become their accomplice.

Metal and wood guide this silent conversation in harmony with the surrounding greenery. Lighting highlights and makes room for the nest, with the delicacy of those who are aware of venturing into an intimate and warm place.

IT *L'inaspettato risiede in Nest, celandosi tra le foglie per diventarne complice.*

Metallo e legno guidano questo dialogo silenzioso in armonia con il verde circostante. L'illuminazione dà risalto e spazio al nido, con la delicatezza di chi è consapevole di avventurarsi in luogo intimo e caldo.





The shape of the nest, inspired by the creations of nature, limits the invasion of human action as much as possible, lighting leaves and green elements in a less invasive manner, blending in with extreme ease with the aesthetics of the greenery.

IT *La forma del nido, ispirata alle creazioni della natura, limita al massimo l'invasione dell'intervento umano, illuminando chiome ed elementi verdi nel modo meno invasivo possibile, amalgamandosi con estrema facilità all'estetica del fogliame.*



An intelligent and
technological "web".
A modern human work.

IT *Un "intreccio" sapiente e tecnologico.
Un moderno/antico lavoro umano.*

The expert hands
of an artisan are
the essence of Nest
and its production.
Someone who has made
wood a passion,
a destiny, a choice.

Landa has linked it
to a functional,
design light.

A perfect light.

In this way, Landa chooses to express its own dec
line taking inspiration from the works of nature, to
give outdoor lighting a human note.

IT *Le mani esperte di un artigiano sono l'essenza Nest
e della sua realizzazione. Colui che del legno ha fatto una
passione, un destino, una scelta. Landa l'ha connesso ad
una luce funzionale e di design.*

Una luce perfetta.

*Landa sceglie di esprimere, in questo modo, la propria
linea dec prendendo spunto dalle opere della natura,
per ridare all'illuminazione outdoor una chiave umana.*



Working cleverly with the Nest web, the artisan composes poetry translated into skill. On one hand, an ancient gesture – the web of wood, an ancestral and symbolic material, which recalls an aesthetic based on the landscape.

On the other, a new modernity which reinterprets the experimentation of the design landscape, which already, in the gardens of the artist Gertrude Jekyll in the XX century, brought to life the green profiles of the whole of Europe, rediscovering an echo in the designs of Landa.

The artisan philosophy of the decorative body of Nest reflects, in connection with the past, a sincere dialogue with Nature. A new design lighting which owes its charm, in reality, to the visual memory of man.

Burrows and birds' nests live in shapes and finishes reproduced manually, with ancient techniques, in symbiosis with the light of the new lighting concept by Landa. In a process where slowness together with uniqueness, is part of the project.

The details in wood, fabric and materials processed with methods very far from predictable mass-production, clad light solutions in a harmonious way.

To celebrate the gifts of Nature through respect and understanding in the creation of a new luminaire, Landa relies on the skill of the artisan. Capable of drawing and lighting new and more sustainable paths, for Nest, the artisan decides to use only trees which have to be cut down because they have reached the end of their life. Together with more ecological choices for finishes, Landa renews its own lighting design vision.

In Nest, the unrepeatable harmony of nature, in this way, meets the meticulous and patient work of the artisan.

IT *L'artigiano, lavorando sapientemente all'intreccio di Nest, compone una poesia tradotta in competenza. Da un lato, un gesto antico - l'intreccio del legno, materiale ancestrale e simbolico, che richiama un'estetica votata al paesaggio.*

Dall'altro una nuova contemporaneità che reinterpreta la sperimentazione del landscape design, che già nei giardini dell'artista Gertrude Jekyll nel XX secolo ha reso vivi i profili verdi di tutta Europa, ritrovando eco nella progettazione Landa.

La filosofia artigianale del corpo decorativo di Nest rispecchia, in connessione con il passato, un sincero dialogo con la Natura. Una nuova illuminazione di design che deve il suo fascino, in realtà, alla memoria visiva dell'uomo.

Tane e nidi di uccelli vivono in forme e finiture riprodotte manualmente, con tecniche antiche, in simbiosi con la luce nel nuovo lighting concept by Landa. In un processo dove la lentezza, insieme all'unicità, è parte del progetto.

I dettagli in legno, tessuti e lavorati con modalità ben lontane dalla prevedibile produzione in serie, rivestono soluzioni luminose in modo armonioso.

Per celebrare i doni della Natura attraverso il rispetto e la comprensione nella realizzazione di un nuovo apparecchio, Landa si affida alla maestria artigianale. Capace di tracciare e illuminare percorsi nuovi e più sostenibili, l'artigiano, per Nest, sceglie di utilizzare solo alberi a fine carriera, abbattuti per necessità. Insieme alle scelte più ecologiche per le finiture, Landa rinnova la propria visione di lighting design.

L'irripetibile armonia della natura incontra, così, in Nest la meticolosa e paziente opera artigianale dell'uomo.





A homage to nature

Nest is a lighting device composed of a **thin web of wooden branches**, worked in an artisan manner.

The structure of the product is sculpted in such a simple material that it interprets a new role, for a new lighting design vision.

The clever web in willow shelters the light source in LED technology which makes Nest **a luminaire to be installed among trees and green leaves**. Thanks to the opal diffuser, the diffused light beam, shining upwards, creates and emphasizes the contrast in previously unknown volumes and recesses.

Available in two versions with different heights and diameters, Nest has an IP65 protection level **ideal for outdoor applications**.

The aesthetic of the product which reminds us of a nest, **blends in with the natural contexts** where it is installed.

IT *Un omaggio alla natura*

*Nest è un apparecchio illuminante composto da un **sottile intreccio di rami di legno**, lavorati artigianalmente.*

La struttura del prodotto è scolpita in una materia così semplice da interpretare un nuovo ruolo, per una nuova visione del lighting design.

*L'abile intreccio in salice dà riparo alla sorgente luminosa in tecnologia LED che fa di Nest **un apparecchio da collocare tra alberi e chiome verdi**. L'emissione luminosa diffusa e orientata verso l'alto creata grazie al diffusore opale, sottolinea il contrasto di volumi e rientranze, prima sconosciuti.*

*Nest, disponibile in due versioni con altezze e diametri diversi, ha un grado di protezione IP65 **ideale per applicazioni outdoor**.*

*L'estetica del prodotto che richiama il nido, **si amalgama ai contesti naturali** dove verrà applicato.*

+ plus



Willow braid

The wooden part of the luminaire is made with woven willow branches treated with a special varnish with nano-particles, making Nest practically indestructible and resistant to any atmospheric agent, without changing its appearance or impeding the transpiration of its natural base.

IT La parte in legno dell'apparecchio illuminante è realizzata con rami di salice intrecciati e trattato con una speciale verniciatura alle nanoparticelle, in grado di rendere Nest praticamente indistruttibile e resistente a qualunque agente atmosferico, senza alterare l'aspetto né impedirne la traspirazione della sua base naturale.

PRODUCT RANGE

A touch of nature
for nature itself.
2 available sizes, Ø 17 cm
and Ø 23.5 cm, for Nest,
the woven nest of willow
branches with an evocative
light.

IT_ *Un tocco di natura per la
natura stessa.
2 dimensioni disponibili,
Ø 17 cm e Ø 23.5 cm, per Nest,
il nido intrecciato di rami di
salice dalla luce evocativa.*



NS70

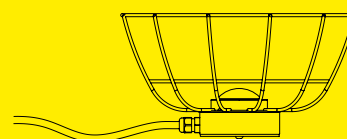

NS80

dimension

17 cm

23.5 cm

LIGHT BEAM

Nest produces a diffused
light beam. Minimum
invasion of the light output
and maximum efficiency,
for the best result in every
outdoor space.

IT_ *Nest è dotato di
emissione luminosa diffusa.
Minima invasività dell'output
luminoso e massima
efficienza, per il miglior
risultato in ogni spazio
outdoor.*

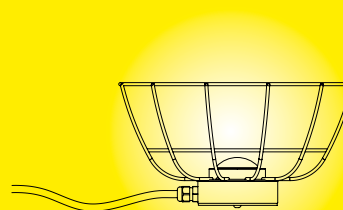

diffuse

beam

nest

An unexpected LANDA product, Nest takes its inspiration from nature.

A luminaire with IP65 protection level, suitable for lighting the branches of trees and hedges in public and private gardens.

Nest's light, with a colour temperature of 3000 K and diffused beam with 8 W power, enhances appliances to the maximum with minimum artificiality.

The dissipating CNC-machined aluminium body is fixed to the steel frame, on which the web of willow branches develops.

At a later stage, the part in natural wood undergoes a nano-particle varnishing treatment to provide maximum resistance to atmospheric agents. The range is available in two different sizes: Ø 17cm H=11 cm and Ø 23.5 cm H=13 cm.

IT *Unexpected product LANDA, Nest si ispira alla natura.*

Apparecchio illuminante con grado di protezione IP65, adatto ad illuminare chiome di alberi e siepi in spazi verdi pubblici e privati.

La luce di Nest, con temperatura colore 3000 K e emissione diffusa con potenza 8 W, valorizza al massimo le applicazioni con la minima artificialità.

Il corpo dissipante in alluminio realizzato con lavorazione CNC è unito al telaio in acciaio, sul quale si sviluppa l'intreccio di rami di salice.

Successivamente la parte in legno naturale è sottoposta ad un trattamento di verniciatura alle nanoparticelle, per la massima resistenza agli agenti atmosferici.

La gamma è disponibile in due diverse dimensioni Ø 17cm H=11 cm e Ø 23.5 cm H=13 cm.

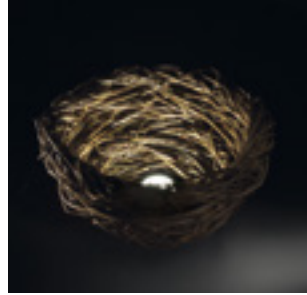
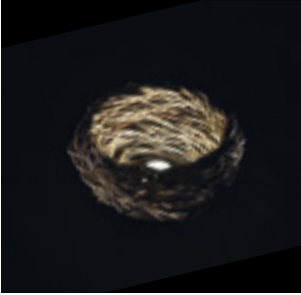

GARDEN LAMP

Wattage 8 WVoltage 220-240 VacBeam Wattage 8 WVoltage 220-240 VacBeam 

TECHNICAL SPECIFICATIONS

Source lamp	<u>LED 8 W</u>
Total wattage	<u>8 W</u>
Voltage	<u>220-240 Vac, 50-60Hz</u>
Control	<u>On/Off</u>
Light colour	<u>3000 K</u>
Luminous flux (*Source flux)	<u>175 lm (640 lm*)</u>
Luminous efficacy	<u>22 lm/W</u>
McADAM steps	<u>3</u>
Beam	<u>Diffuse</u>
CRI	<u>> 90</u>
Life time	<u>L70 > 50.000 h Ta 40°C</u>
IP rating	<u>IP 65</u>
IK rating	<u>IK 08</u>
Insulation class	<u>I</u>

DIFFUSE • Ø 170 MM

Source lamp	<u>LED 8 W</u>
Total wattage	<u>8 W</u>
Voltage	<u>220-240 Vac, 50-60Hz</u>
Control	<u>On/Off</u>
Light colour	<u>3000 K</u>
Luminous flux (*Source flux)	<u>175 lm (640 lm*)</u>
Luminous efficacy	<u>22 lm/W</u>
McADAM steps	<u>3</u>
Beam	<u>Diffuse</u>
CRI	<u>> 90</u>
Life time	<u>L70 > 50.000 h Ta 40°C</u>
IP rating	<u>IP 65</u>
IK rating	<u>IK 08</u>
Insulation class	<u>I</u>

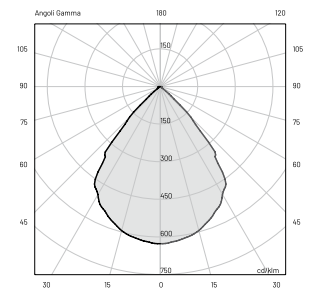

E (LUX)

H (m)	lux (3000 K)	Ø (m)
1.00	122	0.86
2.00	30	1.71
3.00	14	2.57
4.00	8	3.43
5.00	5	4.28

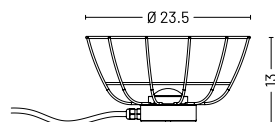
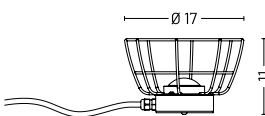

DIFFUSE - Ø 235 MM

LED 8 W

8 W

220-240 Vac, 50-60Hz

On/Off

3000 K

190 lm (640 lm*)

24 lm/W

3

Diffuse

> 90

L70 > 50.000 h Ta 40°C

IP 65

IK 08

I

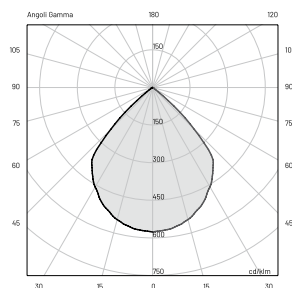
**E (LUX)**

H(m)	lux (3000 K)	Ø(m)
1.00	122	0.94
2.00	30	1.89
3.00	14	2.83
4.00	8	3.78
5.00	5	4.72

MATERIALS

Body Welded steel frame, aluminium heatsink

Diffuser Opal polycarbonate

Finishing Braided willow with nanoparticle painting

ORDER CODE

NS_0 000 D H B 10 G

Diameter 7 Ø 170 mm

8 Ø 235 mm

Example NS 70 000 D H B 10 G

INCLUDED ACCESSORIES

<i>Code</i>	<i>Description</i>
0404M010	Single connection IP68
-	Tree rope
-	2 m length cable H05RN-F

AVAILABLE ACCESSORIES

<i>Code</i>	<i>Description</i>
01083020000V	NS70 debris protection kit
01083030000V	NS80 debris protection kit





tp-lamp

design by Landa R&D

LEGENDS OF LIGHT.

[LEGGENDE DI LUCE.]

CE EAC



88 Everything an Indian does
is in a circle,
and that is because
the power of the world
always works in a circle,
and everything tries to be
round. The sun comes out
and goes down again
in a circle.
The moon does the same
and both are round.
Even the seasons form
a big circle in their change,
and they always go back to
where they were. Our teepees
were round like birds' nests.
And they were always arranged
in a circle, the circle
of the nation.

Black Elk
medicine man and spiritual guide

IT *Tutto quello che fa un indiano è in cerchio, e questo perché il potere del mondo lavora sempre in cerchio, e tutto cerca di essere rotondo. Il sole esce e scende di nuovo in un cerchio. La luna fa lo stesso ed entrambi sono rotondi. Anche le stagioni formano un grande cerchio nel loro cambiamento, e tornano sempre dove erano. I nostri teepee erano rotondi come i nidi degli uccelli. Ed erano sempre disposti in cerchio, il cerchio della nazione.*





**Vast and impalpable Nature
welcomes the night.**

The scent of grass caresses the skin,
which feels, with a shiver, the cold dew.
Far away, a light speaks of ancient tales
lost in the folds of time.

IT_ *Vasta e impalpabile la Natura accoglie la notte.*

Il profumo dell'erba accarezza la pelle che assapora, con un brivido, la rugiada fredda. Lontano, una luce parla di racconti antichi persi nelle pieghe del tempo.



We are
all united
in a circle
of stories.

IT Siamo tutti uniti in un cerchio di storie.



The tribe of the imagination awakens around a fire of light. In a circle, side by side, hand in hand. Towards the starry sky, stories rise, telling of a time long ago. Where men and mountains, animals and flowers, rocks and rivers danced to the rhythm of the earth's cycles.

IT *La tribù dell'immaginazione si risveglia attorno a un fuoco di luce. In cerchio, uno accanto all'altro, mano nella mano. Verso il cielo stellato si innalzano storie che narrano di un tempo lontano. Dove uomini e montagne, animali e fiori, rocce e fiumi danzavano al ritmo dei cicli della terra.*

A ritual that, for Landa, turns into TP-Lamp.

Outdoor spaces once again become home to the secrets of human history, because without sharing there is no memory, without teaching there is no understanding.

TP-Lamp is a guide in the darkest night, a light that returns to make the dormant corners of the past protagonists.

IT *Un rituale che, per Landa, si trasforma in TP-Lamp.*

Gli spazi outdoor tornano ad accogliere i segreti della storia dell'uomo, perché senza condivisione non vi è memoria, senza insegnamento non vi è comprensione.

TP-Lamp è una guida nella notte più scura, una luce che ritorna a rendere protagonisti gli angoli dormienti del passato.



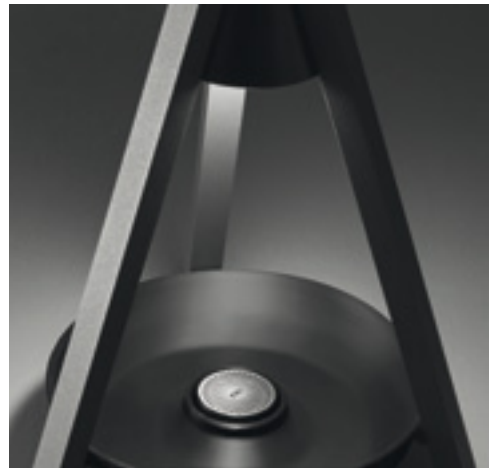
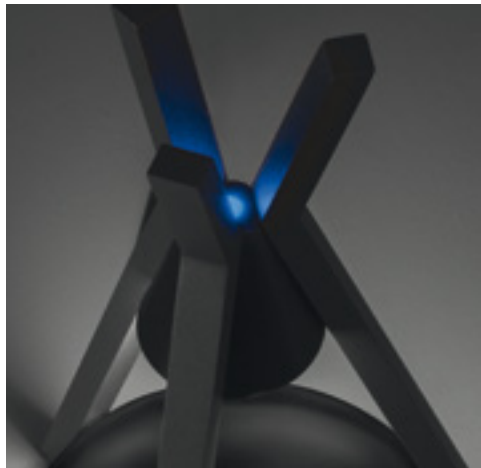

+ plus

Diffuse light

Light is pleasantly diffused, creating Chinese shadow effects on walls or neighbouring surfaces.

IT *La luce risulta piacevolmente diffusa, creando degli effetti a ombre cinesi sulle pareti o sulle superfici vicine.*

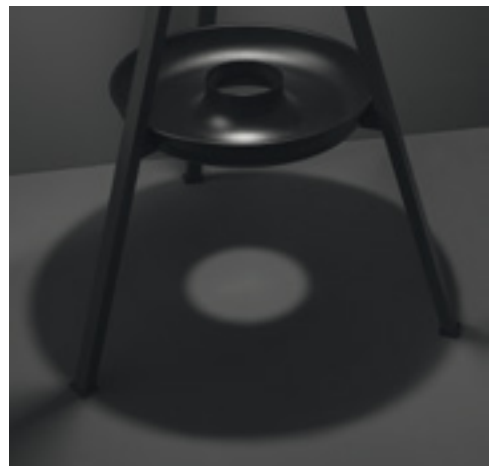

The central pedestal not only serves as a base and support for the product, but also as an excellent base for plants or other objects, giving the lamp a pleasant additional decorative note*.

IT *Il piedistallo centrale, oltre a fare da base e da sostegno al prodotto, è anche un'ottima base d'appoggio per piante o oggetti di vario tipo, regalando così una piacevole nota decorativa aggiuntiva alla lampada stessa*.*



* All objects visible in the photos (green, audio devices and furniture) are for illustrative purposes only and are not included in any way in the LND supply.
Tutti gli oggetti visibili nelle foto (verde, dispositivi audio e mobile) sono a scopo totalmente esemplificativo e non sono inclusi in alcun modo nella fornitura [LND].

TP-Lamp, unexpected range by Landa, a portable Garden Lamp available in two sizes. The small version of the product is also available in a rechargeable version with touch switch and dimmable. The big version has an output of 10W.

IT *TP-Lamp, gamma unexpected by Landa, una portable Garden Lamp disponibile in due dimensioni. La variante small del prodotto è disponibile anche nella versione ricaricabile con accensione touch e dimmerabile. La variante big ha, invece, una potenza di 10W.*

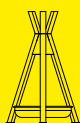

rechargeable

2 W



standard

2 W

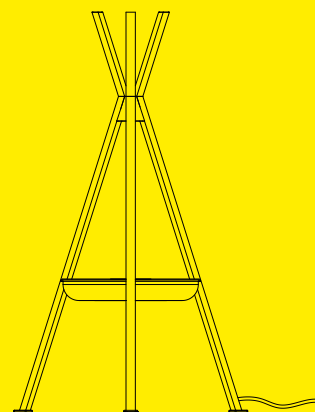

standard

10 W

wattage

LIGHT BEAM

The diffused light emission creates a pleasant and never dazzling effect. The diffuser is in opal polycarbonate for the small table version and in sandblasted glass for the big floor version.

IT *L'emissione luminosa diffusa crea un effetto piacevole e mai abbagliante. Il diffusore è in policarbonato opale per la versione small da tavolo e in vetro sabbato nella versione big da terra.*

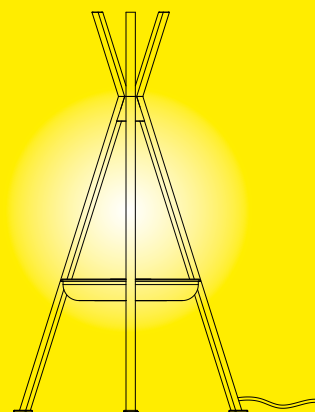

diffuse

FINISHES

* Black lighting body and tray



grey*



graphite*



oxide*

colour



tp-lamp

TP-Lamp is an unexpected product by Landa with IP65 protection. Perfectly recognisable and with a line that decrees its presence in an extraordinary way, TP-Lamp is the perfect companion to use in outdoor spaces to personalise with a touch of design.

TP-Lamp is available in two sizes (small and big), making it suitable for use small and large spaces for impressive atmospheres. Decorative and minimalist, it is decorative and minimalist, it is ideal for gardens, balconies and terraces.

In both cases the colour temperature is a warm white 3000K and both are activated via on/off control on the device.

The body of the product, made of die-cast and extruded aluminium EN AW6026 by CNC machining, has a high degree of mechanical strength and is available in oxide, grey and graphite finishes.

IT TP-Lamp è un prodotto unexpected by Landa con grado di protezione IP65. Perfettamente riconoscibile e con una linea che ne decreta la presenza in modo straordinario, TP-Lamp è il compagno perfetto da utilizzare in spazi outdoor da personalizzare con un tocco di design.

TP-Lamp è proposto in due dimensioni (small e big), rendendolo utilizzabile in spazi piccoli e grandi per atmosfere d'effetto. Decorativo e minimale, si presta ad arredare giardini, balconi e terrazze. In tutti e due i casi la temperatura colore è un bianco caldo a 3000K e sono entrambi attivabili tramite controllo on/off sul dispositivo.

Il corpo del prodotto, realizzato in pressofusione ed estrusione di alluminio EN AW6026 tramite lavorazione CNC, ha un elevato grado di resistenza meccanica ed è disponibile nelle finiture oxide, grey e graphite.



tp-lamp

GARDEN LAMP



Wattage 2 W

Voltage 24 Vdc(standard)

Beam 

TECHNICAL SPECIFICATIONS

	DIFFUSE STANDARD
Source lamp	LED 2 W
Total wattage	2 W
Voltage	24 Vdc
Control	On/Off
Light colour	3000 K
Luminous flux>(*Source flux)	110 lm (290 lm*)
Luminous efficacy	55 lm/W
McADAM steps	3
Beam	diffuse
CRI	> 90
Life time	L80 > 60.000 h Ta 40°C
IP rating	IP 65
IK rating	IK 06
Insulation class	III
Note	

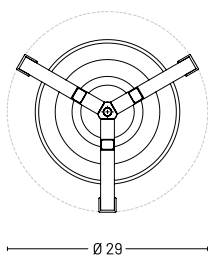
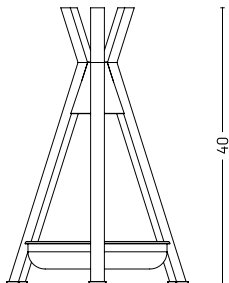



DIFFUSE RECHARGEABLE SWITCH

LED 2 W
2 W
-
On/Off
3000 K
110 lm (290 lm*)
55 lm/W
3
diffuse
> 90
L80 > 60.000 h Ta 40°C
IP 65
IK 06
-
charging port: USB TYPE-C 5 Vdc - 1A

MATERIALS

Body	Die-cast aluminium EN47100 and extruded aluminium EN-AW6060
Diffuser	Opal polycarbonate
Finishing	Polyester powder paint Black lighting body and tray

ORDER CODE

TP 2 0 000 D H B				
	Finishing	H	Grey	
		L	Graphite	
		V	Oxide	
	Supply	7Z	Standard	
		40	Rechargeable	
Example			TP 2 0 000 D H B 7Z L	

INCLUDED ACCESSORIES**STANDARD**

Code	Description
-	2 m length cable

RECHARGEABLE

Code	Description
-	3.7 Vdc Li-Ion battery

AVAILABLE ACCESSORIES**STANDARD**

Code	Description
0409BT014	Transformer _ 24 Vdc - 12 W

RECHARGEABLE

Code	Description
0406BT051	5 Vdc - 3A Universal USB TYPE-C Charger





tp-lamp

GARDEN LAMP



Wattage 10 W

Voltage 220-240 Vac

Beam 

TECHNICAL SPECIFICATIONS

	<u>DIFFUSE STANDARD</u>
Source lamp	<u>LED 7 W</u>
Total wattage	<u>10 W</u>
Voltage	<u>220-240 Vac, 50-60Hz</u>
Control	<u>On/Off</u>
Light colour	<u>3000 K</u>
Luminous flux (*Source flux)	<u>570 lm (880 lm*)</u>
Luminous efficacy	<u>57 lm/W</u>
McADAM steps	<u>3</u>
Beam	<u>diffuse</u>
CRI	<u>> 90</u>
Life time	<u>L80 > 60.000 h Ta 40°C</u>
IP rating	<u>IP 65</u>
IK rating	<u>IK 06</u>
Insulation class	<u>I</u>

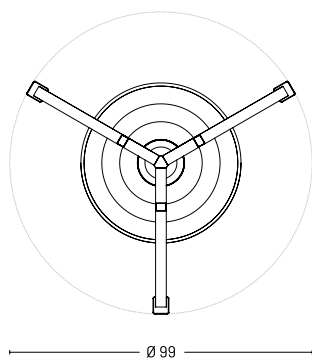
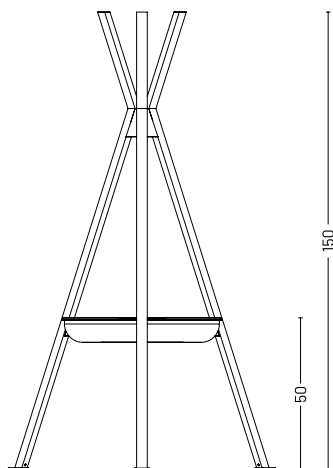

DIFFUSE SWITCH

LED 7 W

10 W

220-240 Vac, 50-60Hz

On/Off

3000 K

570 lm (880 lm*)

57 lm/W

3

diffuse

> 90

L80 > 60.000 h Ta 40°C

IP 65

IK 06

I

MATERIALS*Body* Extruded aluminium EN-AW6060*Diffuser* Sandblasted glass*Finishing* Polyester powder paint
Black lighting body and tray**ORDER CODE**

TP 7 0 000 D H B 1 _ _

*Finishing***H** Grey**L** Graphite**V** Oxide*Supply***0** Standard**S** Switch*Example*TP 2 0 000 D H B **B10 L****INCLUDED ACCESSORIES***Code* *Description*

- Anchor bolt





general information

PROTECTION GRADE GRADO DI PROTEZIONE

IP 44

Luminaire protected against penetration by probes larger than \varnothing 1 mm and protected against spraying water.
Apparecchio protetto da penetrazioni di sonda con \varnothing superiore a 1 mm e protetto dagli spruzzi di acqua.

IP 65

Luminaire dust-tight and protected against water jets.
Apparecchio stagno alla polvere e protetto da getti di acqua.

RESISTANCE TO CRASHES RESISTENZA AGLI URTI

IK 06

Luminaire protected against an impact energy of 1 Joule.
Apparecchio protetto contro un'energia d'impatto di 1 Joule.

IK 08

Luminaire protected against an impact energy of 5 Joules.
Apparecchio protetto contro un'energia d'impatto di 5 Joule.

INSULATION CLASS CLASSE DI ISOLAMENTO

CLASS I

Luminaire with basic insulation. Protection: connection of the accessible metal parts to the earthing protection.
Apparecchio dotato di isolamento di base. Protezione: collegamento delle parti metalliche accessibili alla terra di protezione.

CLASS III

Luminaire suitable for supply at safety extra low voltage. Protection: intrinsically safe. The live parts can be accessed.
Apparecchio idoneo per alimentazione a bassissima tensione di sicurezza. Protezione: intrinsecamente sicuro. Le parti che portano corrente possono essere accessibili.

symbols

360° BEAM
EMISSIONE 360°



DIFFUSE BEAM
EMISSIONE DIFFUSA



VERNICIATURA CON POLVERI DI POLIESTERE
POLYESTER POWDER PAINT

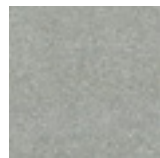

H Grigio
Grey

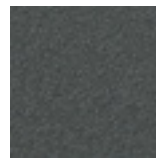

L Graphite
Grafite

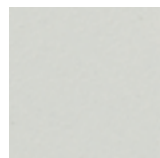

U White
Bianco

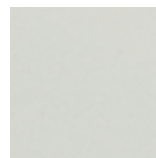

E Marble white
Bianco marmo

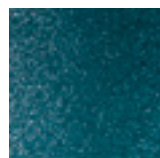

D Green
Verde

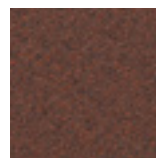

V Oxide
Oxide

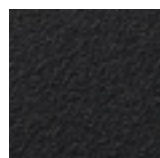

G Black
Nero

quality certifications



CE

Indicates that the product is certified according to European standards.
Indica che il prodotto è certificato secondo le norme europee.



EAC

Indicates that the product conforms to all technical regulations of the evaluation procedures of the Eurasian Customs Union.
Indica che il prodotto si adegua a tutte le normative tecniche delle procedure di valutazione dell'Unione doganale eurasiatica.

LANDA®

Art Direction: Stefano Dall'Osso - SPLD
Technicals: Landa S.p.A.
Photos: F16 Studio
Rendering: Andrea Zani
Concept & Graphic Design: ASB\COMUNICAZIONE
Print: ColorArt

Landa Illuminotecnica S.p.A. si riserva la facoltà di variare o modificare, senza preavviso, le dimensioni e le caratteristiche tecniche dei prodotti indicati in questo catalogo in funzione delle necessità operative, per migliorarne la funzionalità o in adeguamento a normativa di legge.

Landa Illuminotecnica S.p.A. reserves itself the faculty to change or to modify, without advance notice, the dimensions and the technical characteristics of the products indicated in this catalogue, due to operative necessities to improve the functionality or updating with law regulation.

LANDA ILLUMINOTECNICA S.p.A
Via Rosmini, 13/15
25065 Lumezzane
Brescia

+39 0308920966
info@landa.it