

[LND]

italian lighting
for outdoor aesthetics

Best of [LND]

1st edition

Defining, enhancing, customizing and transforming
external architecture

Outdoor light that integrates with the
architecture, makes the spaces livable,
gives them **volume** and **shape**. When necessary
it creates **hypnotic** or relaxing **atmospheres**,
made possible by an **excellent technique**.

Intelligent, reasoned, programmed lighting. Nothing is
left to chance, in continuous dialogue with the natural
light. Perfect lighting designs, thanks to the possibility
of providing a management control that makes even the
simplest of products optimal.

[LND]

IT *Definire l'architettura esterna, valorizzarla, personalizzarla, trasformarla. Luce per spazi outdoor che si integra con l'architettura, la rende vivibile, le dona volume e forma. Quando necessario crea atmosfere ipnotiche o rilassanti, rese possibili da una tecnica impeccabile. Un'illuminazione intelligente, ragionata, programmata. Nulla è lasciato al caso, in dialogo perenne con la luce naturale. Progetti illuminotecnici perfetti, grazie alla possibilità di prevedere un controllo di gestione che rende ottimale anche il più semplice dei prodotti.*

car-go
> 12



EXTENDED RANGE

kuboid
> 62



EXTENDED RANGE

eye
> 22

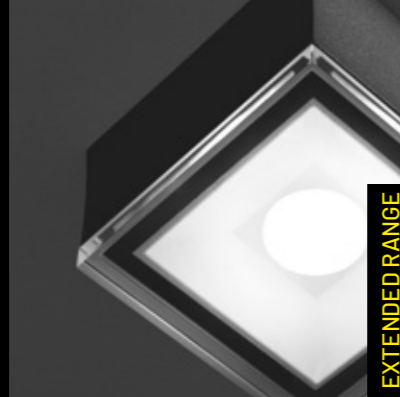

EXTENDED RANGE

firefly
> 34



nest
> 70

fog
> 42

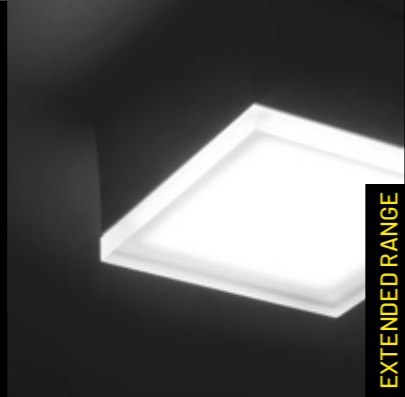

EXTENDED RANGE

tp-lamp
> 76



NEW

wall-i
> 84



NEW

i-lantern
> 52



EXTENDED RANGE

italian lighting
for outdoor aesthetics



Landa's luminaires not only have an IP65/IP67 degree of protection, which makes them suitable for use in outdoor spaces, but also guarantee high technology and light quality.

IT *Gli apparecchi illuminanti Landa oltre ad avere un grado di protezione IP65/67, caratteristica che li rende idone all'utilizzo in spazi esterni, garantiscono una tecnologia e una qualità della luce elevatissime.*

TECH- NOLOGY



Safety

Designed and produced in accordance with current standards for duration and safety, Landa luminaires are specifically designed for outdoor environments. The **tempered glass** of min. 6 mm thickness guarantees maximum **resistance to shocks** and possible vandalism with a mechanical resistance suitable for the type of application.

IT_Sicurezza. Ideati e prodotti secondo le normative vigenti in ottica di **longevità e sicurezza**, gli apparecchi Landa nascono specificatamente per gli spazi outdoor. Il **vetro temprato** dallo spessore minimo di 6 mm garantisce la massima **resistenza agli urti** e ad eventuali atti vandalici con una resistenza meccanica adeguata al tipo di applicazione.

Durability

Aluminum structures perfect for outdoor applications; Landa luminaires **resist oxidation through specific treatments** specially developed in its own research laboratories, **respecting the environment and guaranteeing an ever increasing duration over time**. This allows **minimizing maintenance operations** during the luminaire life.

IT_Durata nel tempo. Strutture in alluminio perfette per le applicazioni outdoor; gli apparecchi Landa **resistono all'ossidazione attraverso degli specifici trattamenti** appositamente messi a punto nei propri laboratori di ricerca, **rispettando l'ambiente e garantendo una sempre maggior durata nel tempo**. Solo in questo modo si possono **ridurre al minimo gli interventi di manutenzione** durante la vita dell'apparecchio illuminante.



High CRI

The **high CRI** (color rendering index) ensures **excellent colour rendering** in an ideal symbiosis with natural light.

IT_CRI elevato. Il **CRI elevato** (alto indice di resa cromatica) **assicura un'eccellente restituzione cromatica dei colori**, in un'ideale simbiosi con la luce naturale.



IRRESISTIBLE STRENGTH

A car in the night, its headlights cut through the shadows. Small lights illuminate the road, creating a light dressing perfect from sunset on, to return home safely. Suitable for paths and driveways, it sits well and is calibrated, lighting up a pathway in a dark starless night.

IT_Forza irresistibile. Un'auto nella notte, i suoi fari fendono le ombre. Piccole luci illuminano la via, creando un dressing di luce perfetto dal tramonto in poi, per tornare in sicurezza a casa. Calpestabile, carrabile, calzante e calibrato è il chiarore di un percorso che contrasta il buio di un'oscurità senza stelle.

Car-go



Car-go_s **NEW**

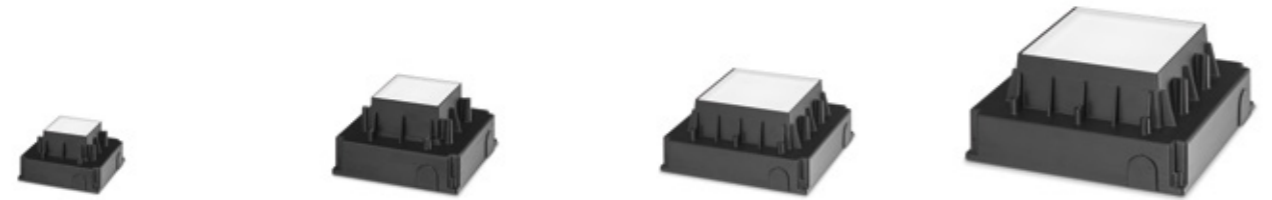

round Ø 5.5 cm
square 5 cm

round Ø 8.5 cm
square 9 cm

round Ø 13 cm
square 12.5 cm

round Ø 20.5 cm
square 20 cm



2000 kg pressure resistance
Resistenza alla pressione fino a 2000 kg



Car-go_L **NEW**



33 cm



61 cm



89.5 cm

3000K 

on request

2700K 

4000K 

Dynamic White 

RGBW 

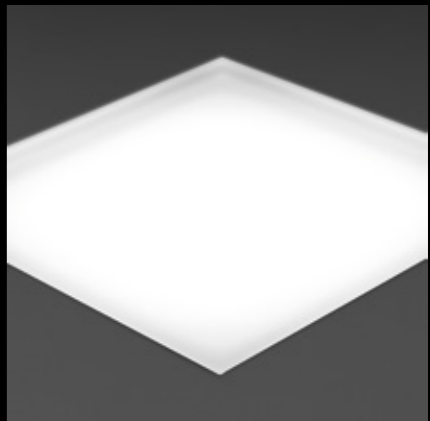

Car-go is an extremely safe and long-lasting product. Its diffuse, glare-free light is pure visual comfort.

IT Car-go è un prodotto estremamente sicuro e longevo. La sua luce diffusa e antiabbagliante è puro comfort visivo.



PERCEPTION IS AN ESSENTIAL LIGHT EMISSION

Compact and perfectly designed. Eye is a ceiling lamp, also available in the recessed version. High lighting efficiency and perfect control of luminance make this product the best choice for outdoor living without shadows.

IT *La percezione è un'essenziale emissione luminosa. Compatta e perfettamente disegnata, Eye è una ceiling lamp, disponibile anche in versione recessed. Un'elevata efficienza luminosa e un perfetto controllo della luminanza segnano questo prodotto come la scelta migliore per un outdoor senza ombre.*

Eye*



Eye_s **NEW**

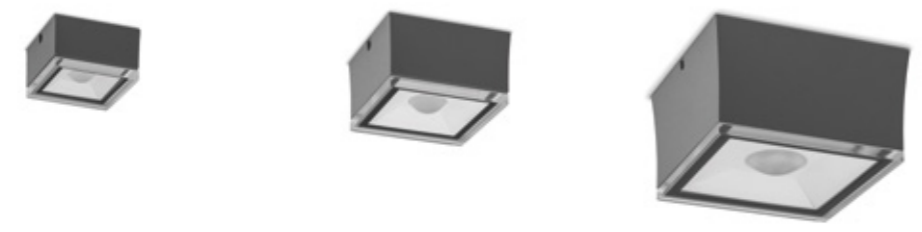

round Ø 8 cm
square 8 cm

round Ø 13 cm
square 12.5 cm

round Ø 21.5 cm
square 20 cm

* recessed version available | disponibile versione recessed

Eye and Eye_s widens their visual field in three light beam models: spot, flood, wide flood.

IT Eye e Eye_s ampliano il suo campo visivo attraverso tre differenti ottiche: spot, flood, wide flood.

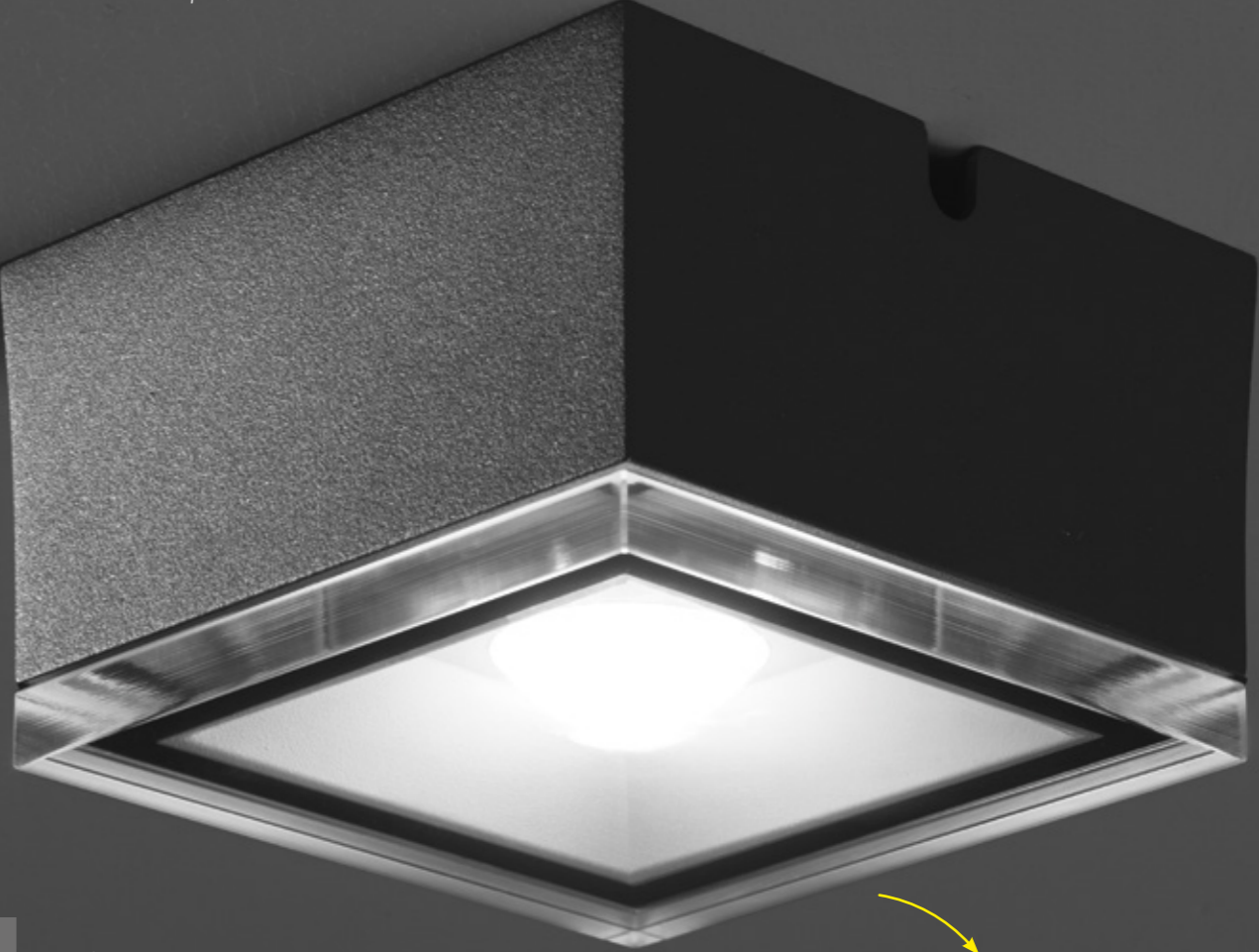

-  spot
-  flood
-  wide flood

extra-clear, transparent, tempered glass

vetro trasparente extrachiaro, temprato

Eye in totally disappearing version for ceiling recessed applications offers flexible technical-lighting potentials which are specific for every project requirement: with just one product it's possible to obtain 3 different aesthetic effects (with protruding, retracting or flush mounting with the fixture kit), thanks to the height adjustment of the appliance inside the casing.

IT Eye nella versione a scomparsa per applicazioni da incasso soffitto offre potenzialità illuminotecniche duttili e specifiche per ogni esigenza progettuale: con un solo prodotto è possibile ottenere 3 diversi effetti estetici (con vetro sporgente, a filo o recesso), grazie alla regolazione in altezza dell'apparecchio all'interno della controcassa.

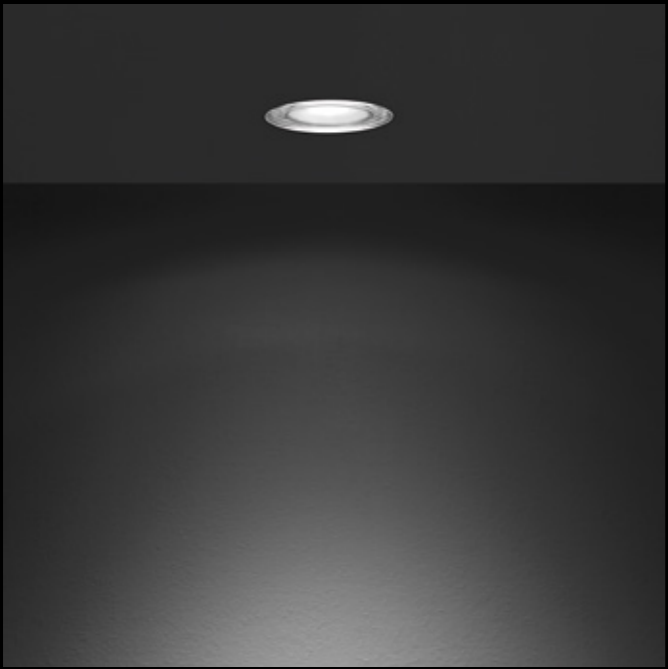

Eye_I* **NEW**

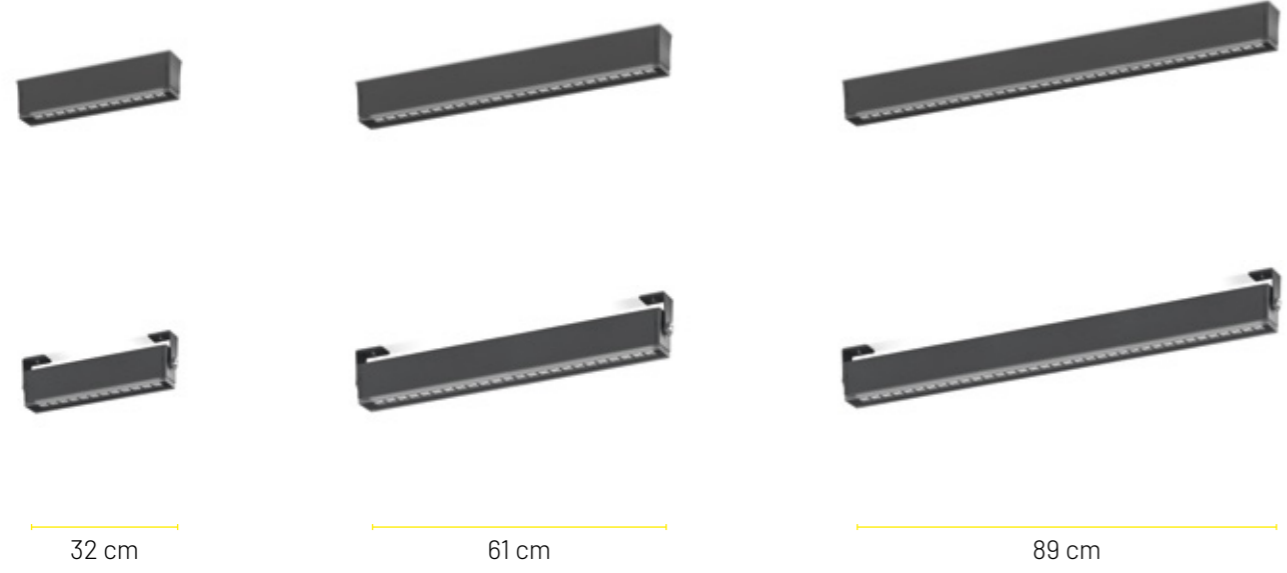

* recessed version available | disponibile versione recessed

-  spot
-  medium
-  flood
-  elliptic
-  grazing

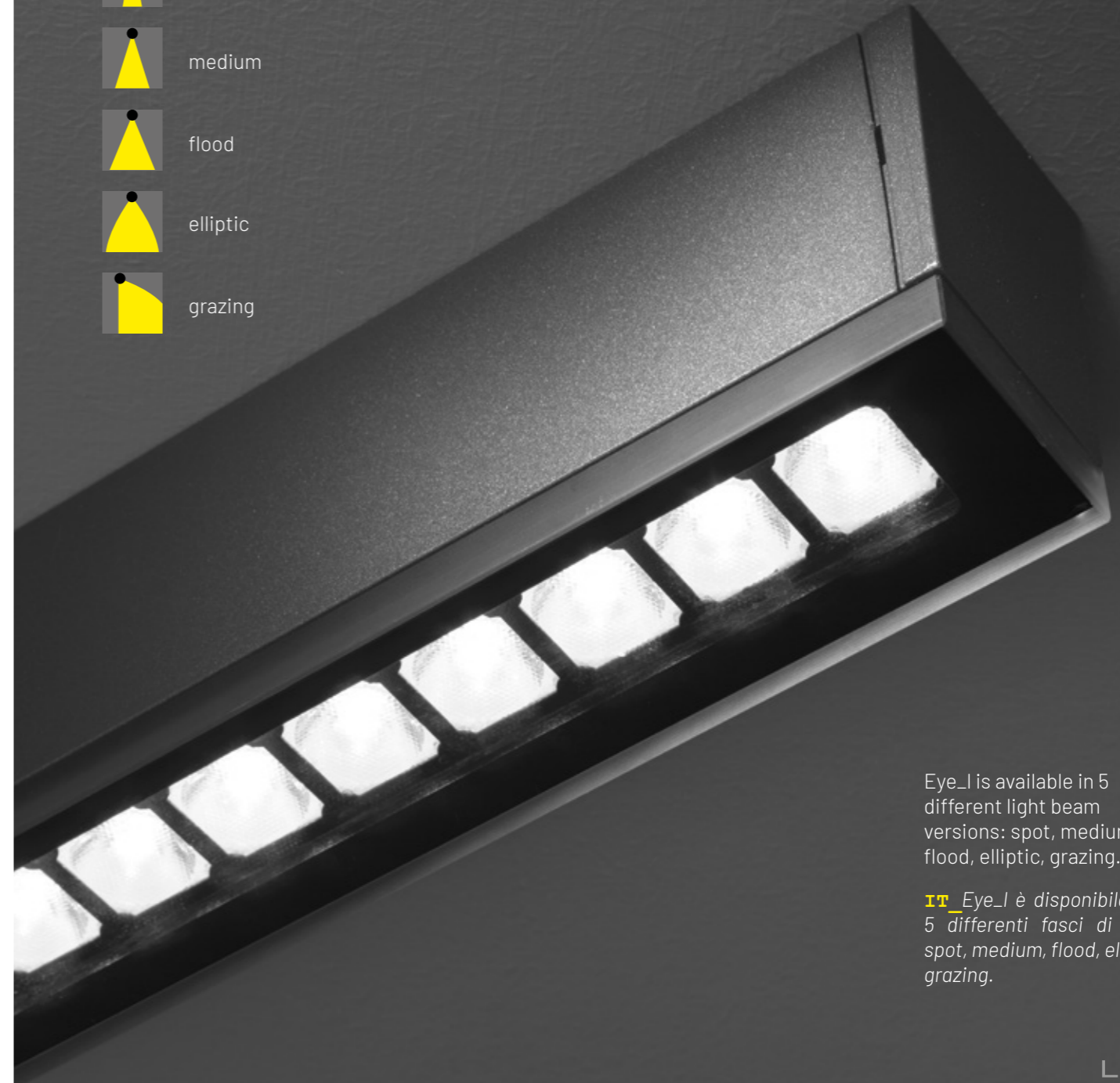

Eye_I is available in 5 different light beam versions: spot, medium, flood, elliptic, grazing.

IT Eye_I è disponibile con 5 differenti fasci di luce: spot, medium, flood, elliptic, grazing.



Eye, strengthened by the extension of the range of new shapes and sizes, is an increasingly versatile luminaire in terms of technology in concept and realisation. Eye_L, the linear version available in three lengths, has three possible modes of installation: ceiling, recessed ceiling and ceiling via brackets that can be swivelled $\pm 120^\circ$ on the vertical axis.

IT *Eye, forte dell'ampiamiento di gamma delle nuove forme e dimensioni, è un apparecchio sempre più versatile tecnologico nel concept e nella realizzazione. Eye_L, la versione lineare disponibile in tre lunghezze, ha tre possibili modalità di installazione: soffitto, incasso soffitto e soffitto tramite staffette orientabili a $\pm 120^\circ$ sull'asse verticale.*

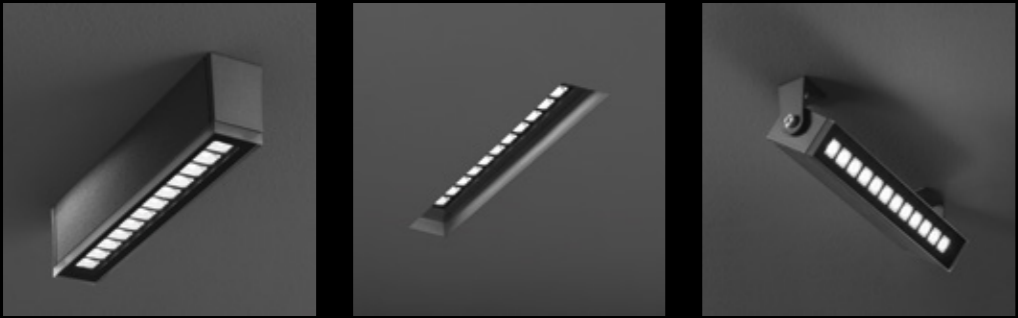

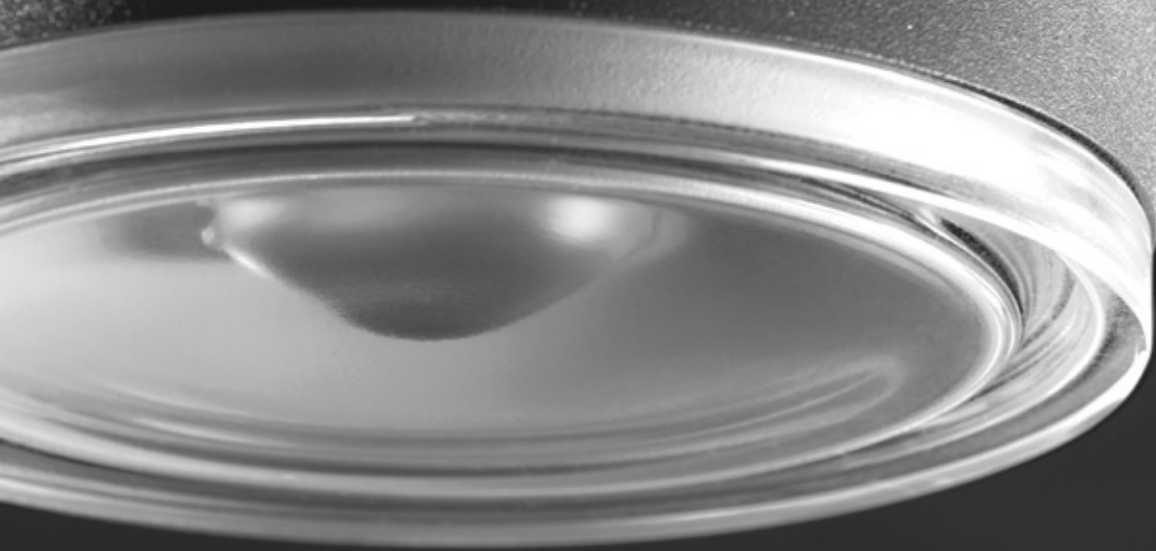

Material and shape. Compact and perfectly designed. Eye is a combination of different materials: glass and aluminium, for a match between technique and aesthetics: grey, graphite, oxide, white, black.

IT *Materiale e forma. Compatta e perfettamente disegnata. Eye è un connubio tra diversi materiali: vetro e alluminio, per un incontro tra tecnica ed estetica. 5 le finiture disponibili: grey, graphite, oxide, white, black.*

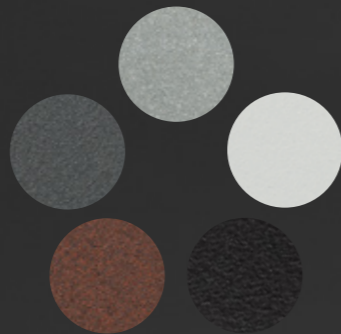

AN OUTDOOR LUMINAIRE, WITH A POETIC SOUL.

Firefly is the first unexpected product by Landa, where the magic of the outdoor world is enriched by a design with a clear reference to nature. So, the tech soul of the Bugatti Group displays itself for the first time with minimalist decorative elements, with a wide reference to an oneiric and dreamlike universe.

IT *Un apparecchio per esterni, con un'anima poetica.*

Firefly è il primo prodotto unexpected by Landa, dove la magia del mondo outdoor si arricchisce di design dal chiaro richiamo naturale. L'anima tech del Gruppo Bugatti si ammanta così, per la prima volta, di elementi propri del decorativo minimale, con un ampio rimando ad un universo onirico e sognante.



19 cm



30 cm



50 cm



70 cm



firefly





A 360° light beam, uniform and attractive, with an opal diffuser in PMMA reminds us of fireflies thanks also to the fact that the luminaire can be **dimmed** and the colours given by the **change in colour temperature**.

Not just an idea, but a veritable communication with surrounding nature is guaranteed by the **installation versatility** (bollard and suspension) which covers **all possible applications** for outdoor garden areas.

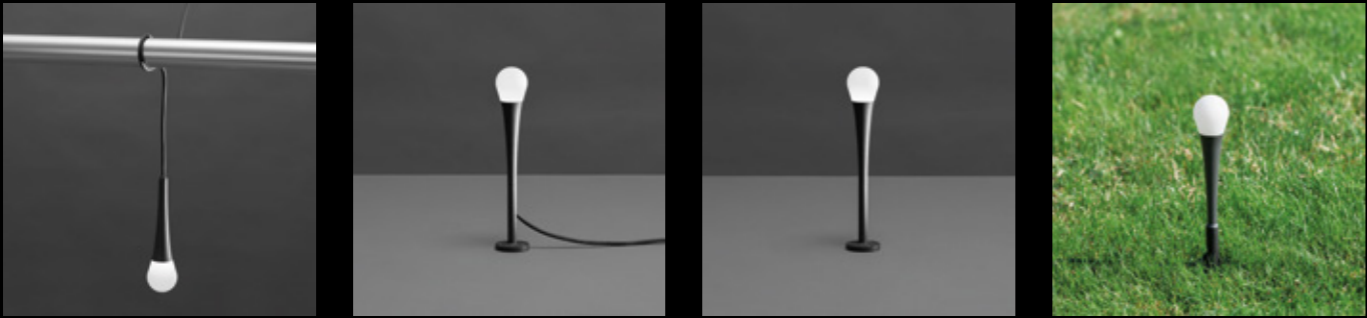
IT *L'emissione luminosa a 360°, uniforme e suggestiva, con diffusore opale in PMMA ricorda le lucciole grazie anche alla **dimmerabilità** dell'apparecchio e ai cromatismi dati dal **cambio della temperatura di colore**.*

*Non solo uno spunto, ma una vera e propria comunicazione con la natura circostante è garantita dalla **versatilità di installazione** (bollard e sospensione) che va a coprire **tutte le possibili applicazioni** per le zone verdi esterne.*



-  3000K
- on request
-  2700K
-  4000K
-  Dynamic White
-  RGBW

firefly

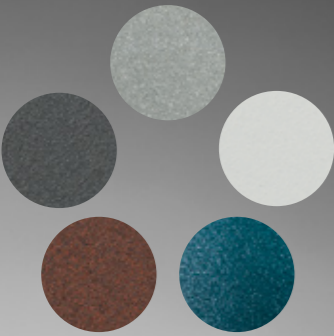

Firefly can merge with nature or stand out from it unmistakably. This is made possible by a choice of five powder-coated finishes: grey, graphite, oxide, white and green.

IT *Firefly può fondersi con la natura o stagliarsi da essa in modo inconfondibile. Questo è possibile grazie alla scelta tra le 5 finiture realizzate con verniciatura a polveri: grey, graphite, oxide, white e green.*



RESISTANCE AND VERSATILITY IN EVERY OUTDOOR CONTEXT

A name which reverses the very concept of its meaning. Reflection and design. Fog is clarity in a three-dimensional form without any shadow. Power and vision, research and innovation, for a technical light fitting with a "classical" form, re-engineered in the most technological way possible.

IT *Resistenza e versatilità in ogni contesto outdoor. Un nome che ribalta il concetto stesso del suo significato. Riflessione e progettazione, Fog è chiarezza in forma tridimensionale senza ombra alcuna. Potenza e visione, ricerca e innovazione, per un apparecchio tecnico dalla forma "classica", ri-ingegnerizzato nel modo più tecnologico possibile.*

EXTENDED RANGE

Fog*



Fog_s* **NEW**

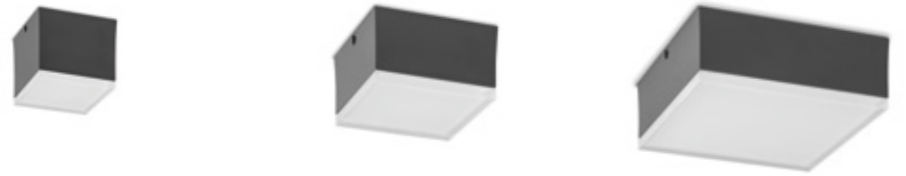

round Ø 8.5 cm
square 8 cm

round Ø 13 cm
square 12.5 cm

round Ø 20.5 cm
square 20 cm

* recessed version available | disponibile versione recessed



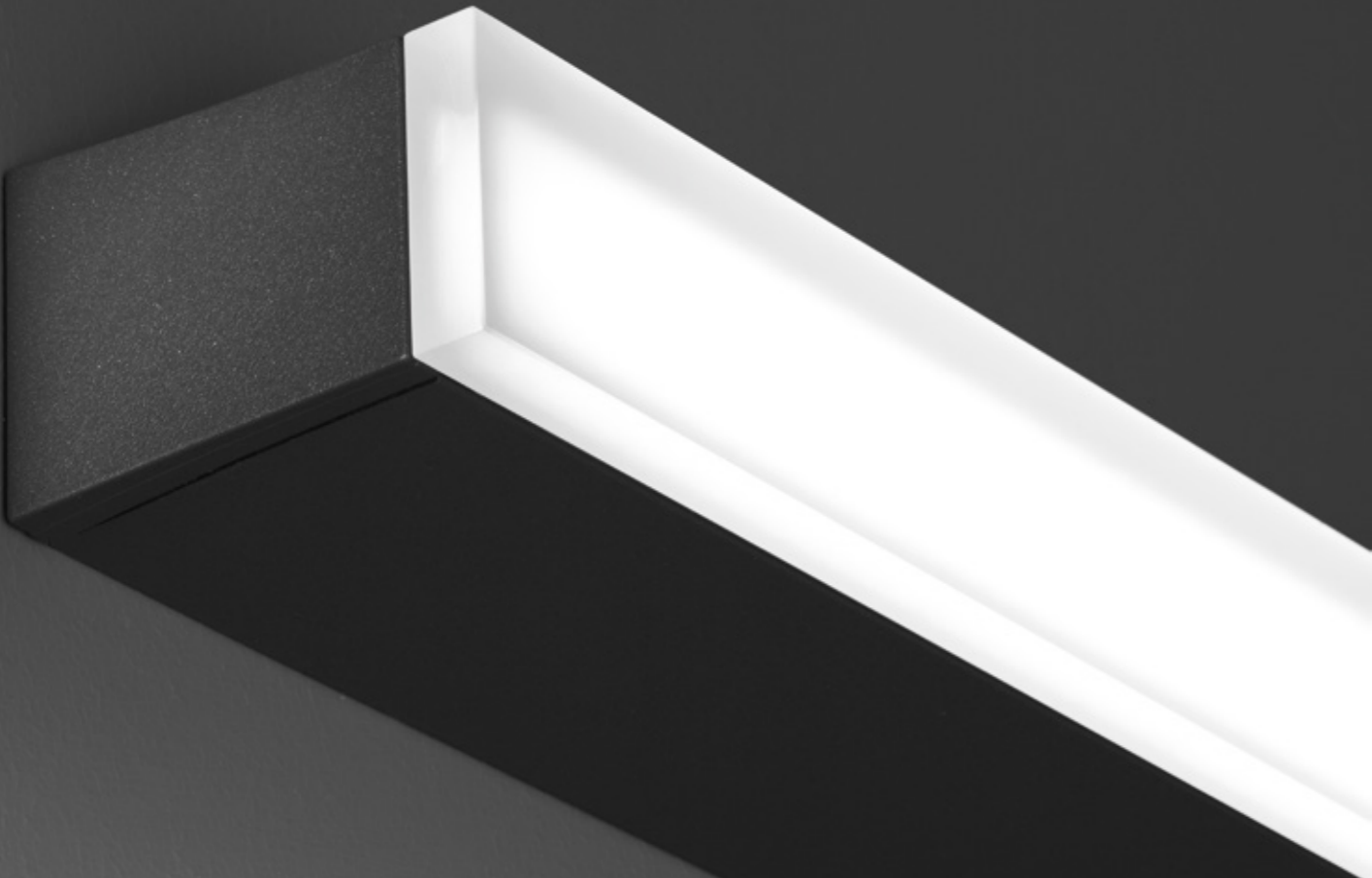

Fog_L* **NEW**

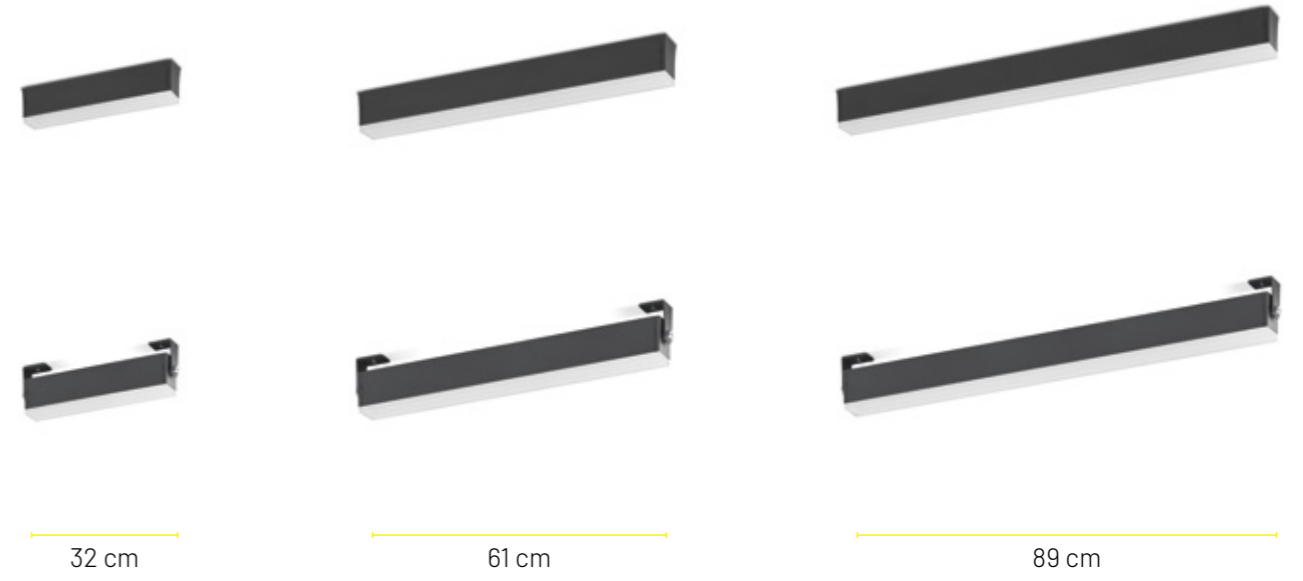

* recessed version available | disponibile versione recessed

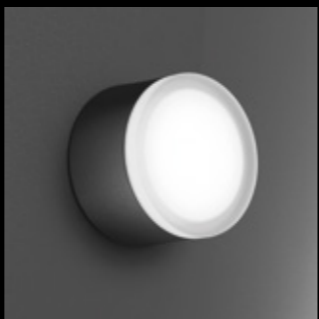
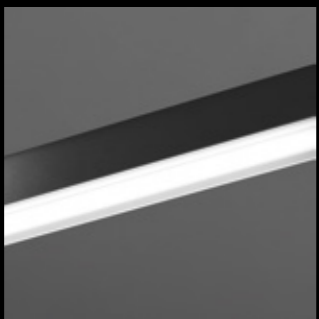
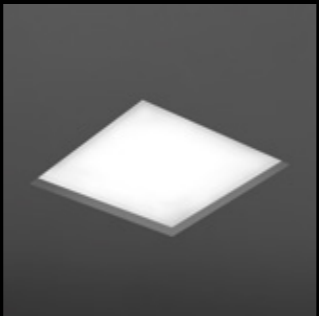

1 family, 3 shapes, 3 sizes, 4 applications. Fog is a complete solution for lighting different environments with different requirements, guaranteeing aesthetic consistency and maximum durability.

IT 1 famiglia, 3 forme, 3 dimensioni, 4 applicazioni. Fog è una soluzione completa per l'illuminazione di ambienti diversi e con differenti esigenze, garantendo una coerenza estetica e una massima resistenza nel tempo.



3000K 

on request

2700K 

4000K 

Dynamic White 

RGBW 



Extremely durable, Fog has a die-cast aluminium body that can be customised in five different finishes, thus combining technology with aesthetics.

IT Estremamente resistente, Fog ha un corpo in alluminio pressofuso personalizzabile in cinque diverse finiture e così la tecnica si unisce all'estetica.



SHADOWS THAT DANCE

I-Lantern is characterised by a strong personality, a direction of light. An aesthetic fusion living parallel with a minimal design to provide a wide range of possible installations.

IT_Ombre che danzano. I-Lantern si presenta caratterizzato da una forte personalità, una regia luminosa. Una fusione estetica che vive in parallelo ad un design minimal per declinarsi in molteplici possibili installazioni.



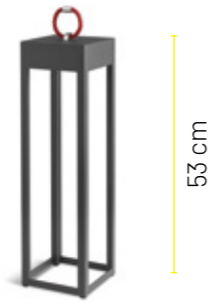
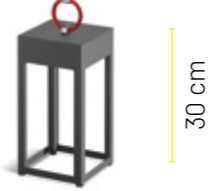

NEW

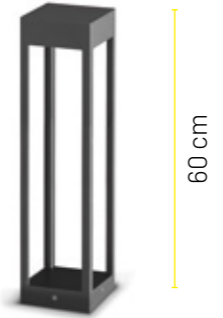
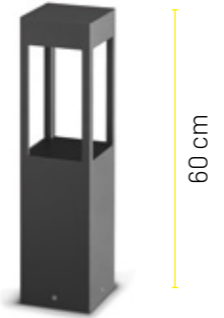

NEW

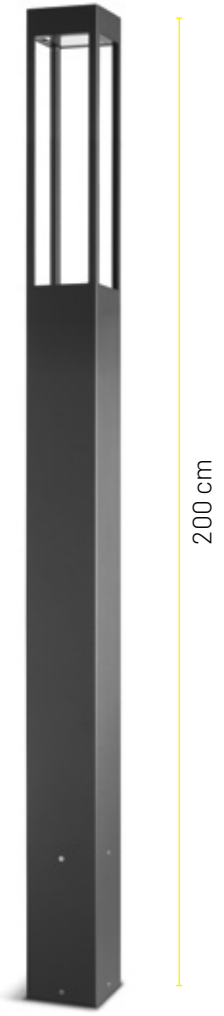
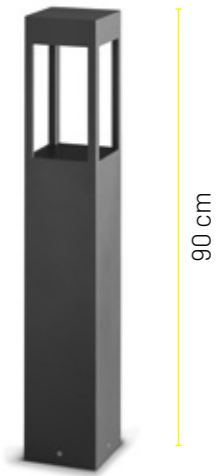

NEW



i-lantern

Gardens, walkways, arcade, tables. Thanks to the completeness of the range, with I-Lantern an entire outdoor context can be illuminated with aesthetic consistency and high performance.

IT *Giardini, camminamenti, portici, tavoli. Grazie alla completezza di gamma, con I-Lantern è possibile illuminare con coerenza estetica e alte performance un intero contesto outdoor.*

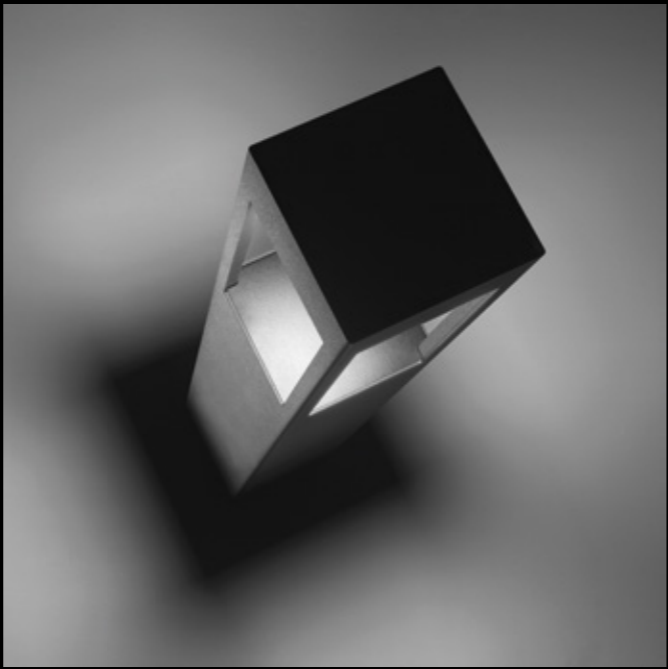

The standing version is also re-chargeable and self-feeding, has an autonomy of 3 hours at the maximum power.

IT *La variante da appoggio è anche ricaricabile, ha un'autonomia di 3 ore alla massima potenza.*



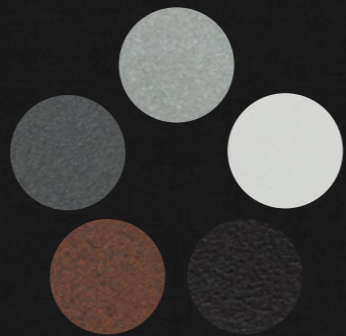

An aesthetic fusion that lives in parallel with a minimalist design to be declined in multiple possible installations and five different finishes.

IT *Una fusione estetica che vive in parallelo ad un design minimal per declinarsi in molteplici possibili installazioni e cinque finiture differenti.*



THE PERFECT SHAPE ELEVATED TO THE HIGHEST POWER

A regular polyhedron, a projector with six sides and twelve equal angles. Outdoor living takes on a new quality, thanks to the infinite light of Kuboid, which can be adjusted and directed according to individual technical-lighting needs.

IT *Forma perfetta elevata all'ennesima potenza. Un poliedro regolare, un proiettore con sei facce e dodici spigoli uguali. L'outdoor prende nuova vita, grazie alla luce infinita di Kuboid, orientabile e direzionabile sulla base delle singole necessità illuminotecniche.*









NEW

Kuboid exists with 4 light beams: spot, medium, flood (wide flood for the *mini* version), grazing (elliptic for the *mini* version) and is also available with opal glass for producing diffused light.

IT *Kuboid esiste con 4 differenti fasci di luce: spot, medium, flood (wide flood per la versione mini), grazing (elliptic per la versione mini) ed è disponibile anche con vetro opale, con emissione luminosa diffusa.*

-  spot
-  medium
-  flood
-  grazing
-  diffuse



kuboid

Kuboid is synonymous with extreme versatility, a quality generated by the possibility of rotating the light fitting $\pm 120^\circ$ on the horizontal axis and 90° on the vertical one. It offers four possible applications: ceiling, wall, floor and ground installation via steel stakes.

IT Kuboid è sinonimo di estrema versatilità, qualità generata dalla possibilità di rotazione dell'apparecchio di $\pm 120^\circ$ sull'asse orizzontale e di 90° su quello verticale. Ha quattro possibili applicazioni: soffitto, parete, pavimento e terreno tramite picchetto in acciaio.

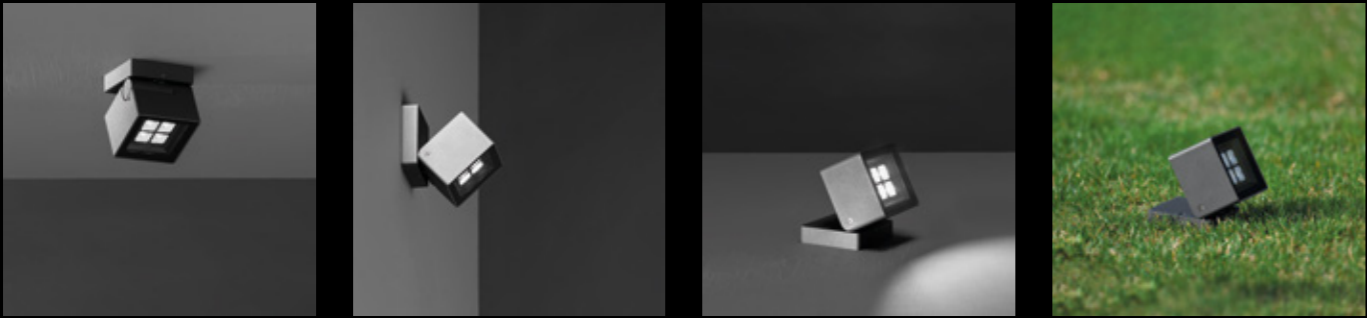
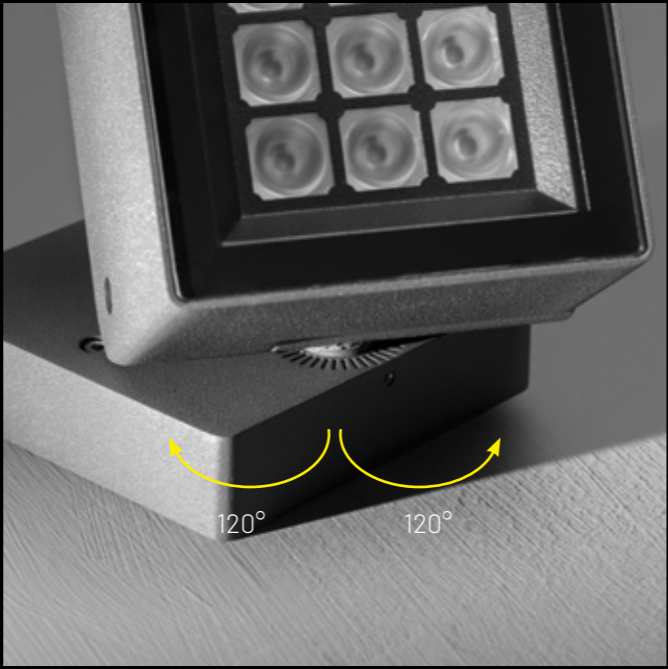

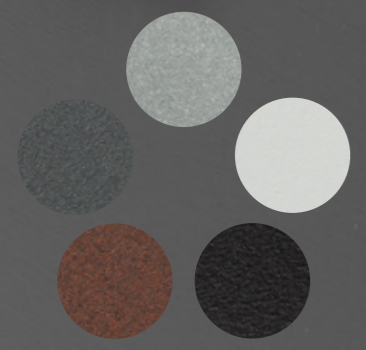

Kuboid has a geometric identity but also a customisable look in five different finishes created through the use of powder varnishing: grey, graphite, oxide, white, black.

IT *Kuboid ha un'identità geometrica ma veste un'estetica personalizzabile in cinque diverse finiture realizzate tramite verniciatura a polveri: grey, graphite, oxide, white, black.*



A TRIBUTE TO NATURE

The unexpected can be found in **Nest**, hiding among the leaves to become their accomplice. Metal and wood guide this silent conversation **in harmony with the surrounding greenery**. Lighting highlights and makes room for the nest, with the delicacy of those who are aware of venturing into an intimate and warm place.

IT *Un omaggio alla natura*. L'inaspettato risiede in **Nest**, celandosi tra le foglie per diventarne complice. Metallo e legno guidano questo dialogo silenzioso **in armonia con il verde circostante**. L'illuminazione dà risalto e spazio al nido, con la delicatezza di chi è consapevole di avventurarsi in luogo intimo e caldo.





17 cm



23.5 cm



WILLOW WEAVE
treated with a special
varnish with nano-particles

IT_ Intreccio di salice
trattato con una
speciale verniciatura
alle nanoparticelle



WE ARE ALL UNITED IN A CIRCLE OF STORIES

Outdoor spaces once again become home to the secrets of human history, because without sharing there is no memory, without teaching there is no understanding. TP-Lamp is a guide in the darkest night, a light that returns to make the dormant corners of the past protagonists.

IT_Siamo tutti uniti in un cerchio di storie. Gli spazi outdoor tornano ad accogliere i segreti della storia dell'uomo, perché senza condivisione non vi è memoria, senza insegnamento non vi è comprensione. TP-Lamp è una guida nella notte più scura, una luce che ritorna a rendere protagonisti gli angoli dormienti del passato.



Light is pleasantly diffused, creating Chinese shadow effects on walls or neighbouring surfaces

IT *La luce risulta piacevolmente diffusa, creando degli effetti a ombre cinesi sulle pareti o sulle superfici vicine*



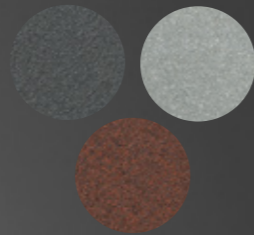

The body of the product, made of die-cast and extruded aluminium EN AW6026 by CNC machining, has a high degree of mechanical strength and is available in oxide, grey and graphite finishes.

IT *Il corpo del prodotto, realizzato in pressofusione ed estrusione di alluminio EN AW6026 tramite lavorazione CNC, ha un elevato grado di resistenza meccanica ed è disponibile nelle finiture oxide, grey e graphite.*

The central pedestal not only serves as a base and support for the product, but also as an excellent base for plants or other objects, giving the lamp a pleasant additional decorative note*.

IT *Il piedistallo centrale, oltre a fare da base e da sostegno al prodotto, è anche un'ottima base d'appoggio per piante o oggetti di vario tipo, regalando così una piacevole nota decorativa aggiuntiva alla lampada stessa*.*

* All objects visible in the photos (green, audio devices and furniture) are for illustrative purposes only and are not included in any way in the LND supply.
Tutti gli oggetti visibili nelle foto (verde, dispositivi audio e mobile) sono a scopo totalmente esemplificativo e non sono inclusi in alcun modo nella fornitura [LND].





A NAME AND NO LIMITS

Wall-i is the new wall-mounted luminaire from [LND]. Compact and three-dimensional, it breaks the linearity of walls and is hyper-resistant.

IT *Un nome e nessun limite.* Wall-i è il nuovo apparecchio per installazione a parete di [LND]. Compatto e tridimensionale, rompe la linearità delle pareti ed è iper resistente.



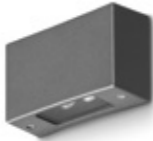

10 cm



16 cm





The special feature of Wall-i is the wide range of optics. Seven are available: spot, medium, wide flood, elliptic, asymmetric, double asymmetric, double spot/asymmetric to meet every lighting requirement.

IT *La particolarità di Wall-i è l'ampia gamma di ottiche. Ne sono disponibili sette: spot, medium, wide flood, elliptic, asymmetric, double asymmetric, double spot/asymmetric per soddisfare ogni esigenza di illuminazione.*

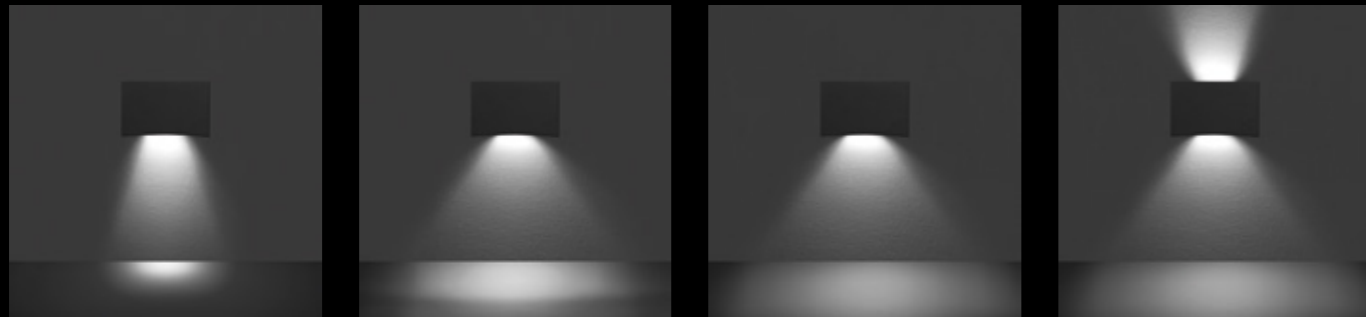

-  spot
-  medium
-  wide flood
-  elliptic
-  asymmetric
-  double asymmetric
-  double spot/asymmetric

Two sizes and five finishes are available, making every lighting requirement tangible and consistent with the context.

IT *Due dimensioni e cinque finiture disponibili, per rendere ogni esigenza illuminotecnica tangibile e coerente con il contesto.*



Landa lights up outdoor spaces with numerous accompanying proposals. Efficient and transversal ranges, lighting solutions able to satisfy the needs of the project designer in the most complete way possible for integrated lighting and lighting which can fit in everywhere.

IT Landa illumina l'outdoor con numerose soluzioni a corredo. Gamme efficienti e trasversali, proposte luminose in grado di rispondere al progettista nel modo più completo possibile per un'illuminazione integrata e integrabile.

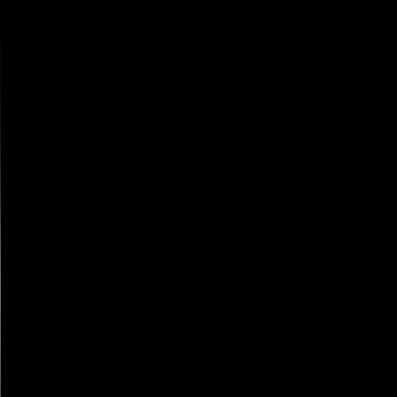
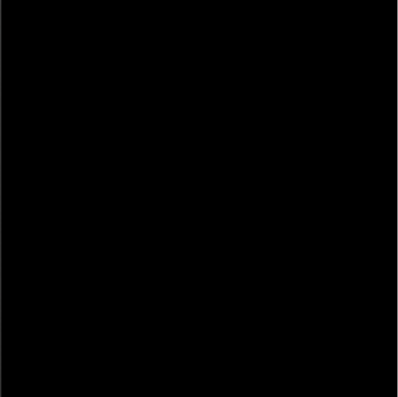
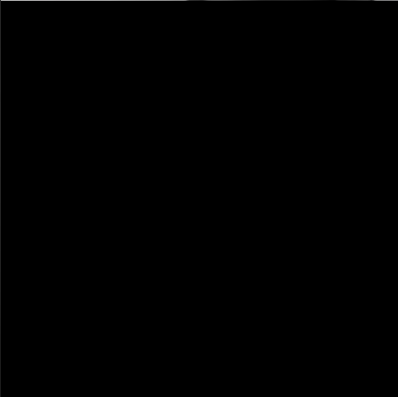
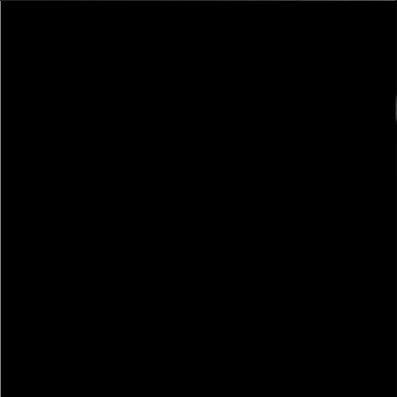
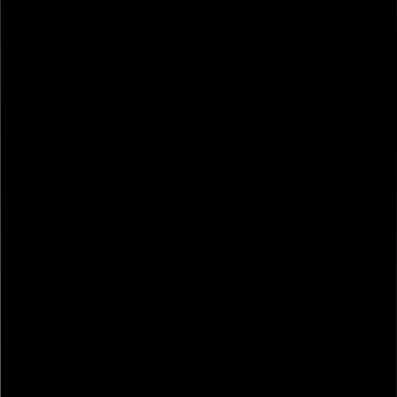
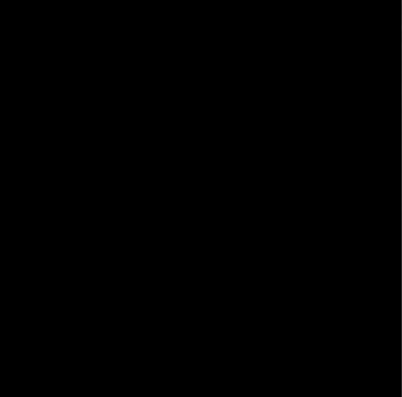
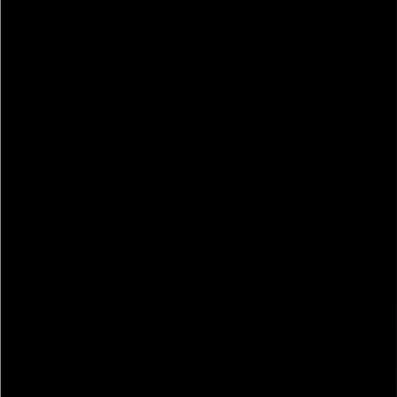
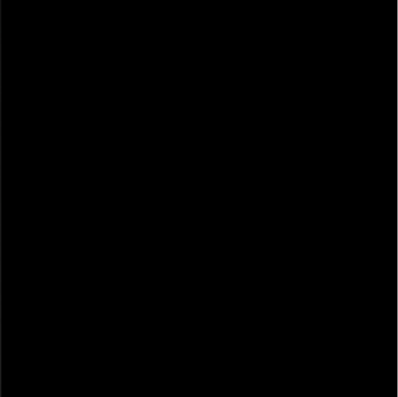

LANDA®

Art Direction: Stefano Dall'Osso - SPLD
Technicals: Landa S.p.A.
Photos: F16 Studio
Rendering: Andrea Zani
Concept & Graphic Design: ASB\COMUNICAZIONE
Print: ColorArt

LANDA ILLUMINOTECNICA S.p.A

Via Rosmini, 13/15

25065 Lumezzane

Brescia

+39 0308920966

info@landa.it